

Cam Positioner H8PS

CSM_H8PS_DS_E_6_2

This Compact Cam Positioner, Popular for Its Ease-of-use, Now Comes with Even Better Functions.

- Compact 8-, 16-, and 32-output Models available that are 1/4-DIN size at 96 x 96 mm.
- High-speed operation at 1,600 r/min and high-precision settings to 0.5° ensure widespread application.
- Highly visible display with backlit negative transmissive LCD.
- Advance angle compensation function to compensate for output delays.
- Bank function for multi-product production (8 banks). (H8PS-16□/-32□ models.)
- Speed display and pulse output.
- Approved standards: UL/CSA and EMC.



Refer to **Safety Precautions for All Counters and Safety Precautions** on page 18 and 19.

Features

Models with 8, 16, or 32 Outputs

The lineup includes Models with 32 outputs in a compact 1/4-DIN size. Using the optional Parallel Input Adapter (Y92C-30) enables expanding to up to 64 outputs for one encoder to support anything from a simple positioning application to a large-scale system.

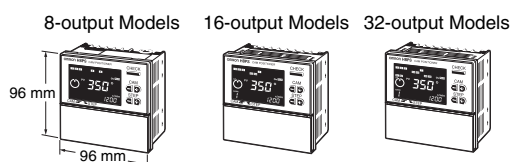

Simple Programming

The programming method is designed based on a one key-one action concept for settings that could not be simpler. Both initial settings and factory adjustments are effort-free.

Large, Backlit Negative LCDs

Large LCDs, red for the process value and green for set values, show a wealth of operation information, making operating status visible at a glance.

High Speed Up To 1,600 r/min High Precision Up To 0.5° (at 720 Resolution)

High-speed, high-precision applications can be easily handled and productivity increased.

Bank Function for Multi-product Production

Up to eight different programs can be registered in advance to enable fast and easy switching between products (16/32-output Models only).

USB Communications for Easy Setting from a Computer

Optional Support Software can be used to enable programming from a personal computer via USB communications. Programs can be easily copied, saved, printed, and much more.

Speed Display and Speed Alarm Output

Both the speed (rotations/minutes) and present angular position can be displayed at the same time. Alarm outputs can be produced for both upper and lower speed limits.

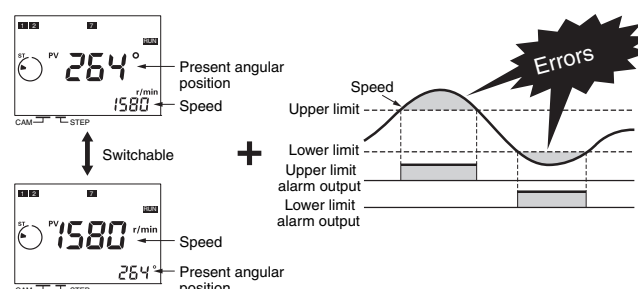

Advance Angle Compensation Function to Compensate for Output Delays

The advance angle compensation (ADV) function automatically advances the ON/OFF angle of outputs in proportion to machine (encoder) speed to compensate for the delay in timing of ON/OFF operation. ADV values can be set individually for 7 cam outputs.

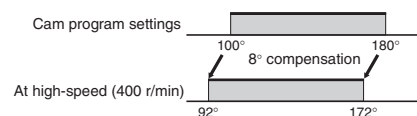

Pulse Output for Timing Control

The number of pulses per rotation and the pulse output start angle can be set to enable operations like adjusting timing with a PLC or outputting to a rotation meter.

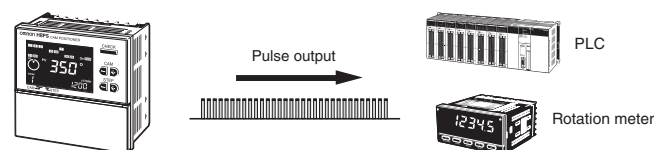

Model Number Structure

■ Model Number Legend

H8PS-□□□□
1 2 3 4

1. **Number of outputs**
8: 8 outputs
16: 16 outputs
32: 32 outputs

2. **Panel language**
B: English

3. **Mounting method**
None: Flush mounting
F: Surface mounting/
track mounting

4. **Output configuration**
None: NPN transistor output
P: PNP transistor output

Ordering Information

■ List of Models

Cam Positioner

Number of outputs	Mounting method	Output configuration	Bank function	Model
8 outputs	Flush mounting	NPN transistor output	No	H8PS-8B
		PNP transistor output		H8PS-8BP
	Surface mounting/ track mounting	NPN transistor output		H8PS-8BF
		PNP transistor output		H8PS-8BFP
16 outputs	Flush mounting	NPN transistor output	Yes	H8PS-16B
		PNP transistor output		H8PS-16BP
	Surface mounting/ track mounting	NPN transistor output		H8PS-16BF
		PNP transistor output		H8PS-16BFP
32 outputs	Flush mounting	NPN transistor output		H8PS-32B
		PNP transistor output		H8PS-32BP
	Surface mounting/ track mounting	NPN transistor output		H8PS-32BF
		PNP transistor output		H8PS-32BFP

Dedicated Absolute Encoder

Type	Resolution	Cable length	Model
Economy	256	2 m	E6CP-AG5C-C 256P/R 2M
Standard	256	1 m	E6C3-AG5C-C 256P/R 1M
		2 m	E6C3-AG5C-C 256P/R 2M
	360		
	720		E6C3-AG5C-C 720P/R 2M
Rigid	256	2 m	E6F-AG5C-C 256P/R 2M
	360		E6F-AG5C-C 360P/R 2M
	720		E6F-AG5C-C 720P/R 2M

Accessories (Order Separately)

Name	Specification	Model
Discrete Wire Output Cable	2 m	Y92S-41-200
Connector-type Output Cable	2 m	E5ZE-CBL200
Support Software	CD-ROM	H8PS-SOFT-V1
Shaft Coupling for the E6CP	Axis: 6 mm dia.	E69-C06B
Shaft Coupling for the E6C3	Axis: 8 mm dia.	E69-C08B
Shaft Coupling for the E6F	Axis: 10 mm dia.	E69-C10B
Extension Cable (See note.)	5 m (same for E6CP, E6C3, and E6F)	E69-DF5
Parallel Input Adapter	Two Units can operate in parallel.	Y92C-30
Protective Cover	---	Y92A-96B
Watertight Cover	---	Y92A-96N
Track Mounting Base	---	Y92F-91
Mounting Track	50 cm × 7.3 mm (ℓ × t)	PFP-50N
	1 m × 7.3 mm (ℓ × t)	PFP-100N
	1 m × 16 mm (ℓ × t)	PFP-100N2
End Plate	---	PFP-M
Spacer	---	PFP-S

Note: Ask your OMRON representative about the availability of non-standard lengths.

Recommended USB Cables

Name	Recommended manufacturer	Specification	Model
USB Cable	ELECOM CO.Ltd.	A-miniB, 2m	U2C-MF20BK

Note: If you can't purchase recommended replacement, please purchase commercially available USB cable that attached ferrite core.

Specifications

■ Ratings

Item		H8PS-□B	H8PS-□BF	H8PS-□BP	H8PS-□BFP
Rated supply voltage		24 VDC			
Operating voltage range		85% to 110% of rated supply voltage			
Mounting method		Flush mounting	Surface mounting, track mounting	Flush mounting	Surface mounting, track mounting
Power consumption		Approx. 4.5 W at 26.4 VDC for 8-output models Approx. 6.0 W at 26.4 VDC for 16-/32-output models			
Inputs	Encoder input		Connections to a dedicated absolute encoder		
	External inputs	Input signals	8-output Models: None 16-/32-output Models: Bank inputs 1/2/4, origin input, start input		
		Input type	No voltage inputs: ON impedance: 1 kΩ max. (Leakage current: approx. 2 mA at 0 Ω) ON residual voltage: 2 V max., OFF impedance: 100 kΩ min., Applied voltage: 30 VDC max. Minimum input signal width: 20 ms		
Outputs	Cam outputs RUN output		NPN open-collector transistor outputs 30 VDC max., 100 mA max. (Do not exceed 1.6 A total for all cam outputs and the RUN output.), residual voltage: 2 VDC max.	PNP open-collector transistor outputs 30 VDC max. (26.4 VDC for 16-/32-output Models), 100 mA max. (Do not exceed 1.6 A total for all cam outputs and the RUN output.), residual voltage: 2 VDC max.	
	Pulse output		NPN open-collector transistor output 30 VDC max., 30 mA max., residual voltage: 0.5 VDC max.	PNP open-collector transistor output 30 VDC max. (26.4 VDC for 16-/32-output Models) 30 mA max., residual voltage: 2 VDC max.	
	Number of outputs		8-output Models: 8 cam outputs, 1 RUN output, 1 pulse output 16-output Models: 16 cam outputs, 1 RUN output, 1 pulse output 32-output Models: 32 cam outputs, 1 RUN output, 1 pulse output		
Number of banks		8 banks (for 16-/32-output Models only)			
Display method		7-segment, negative transmissive LCD (Main Display: 11 mm (red), Sub-display: 5.5 mm (green))			
Memory backup method		EEPROM (overwrites: 100000 times min.) that can store data for 10 years min.			
Ambient operating temperature		-10 to 55°C (with no icing or condensation)			
Storage temperature		-25 to 65°C (with no icing or condensation)			
Ambient humidity		25% to 85%			
Degree of protection		Panel surface: IP40, Rear case: IP20			
Case color		Light gray (Munsell 5Y7/1)			

■ Characteristics

Setting unit		0.5° increments at a resolution of 720, 1° increments at a resolution of 256 or 360 (See note 1.)
Number of steps		Up to 10 steps can be set for each cam to turn the output ON/OFF 10 times. (See note 2.)
Inputs	Encoder input	Connections to a dedicated absolute encoder <ul style="list-style-type: none"> • Response rotation speed (in Run/Test Mode) 1600 r/min max. at a resolution of 256 or 360 (1200 r/min max. if ADV function is set for 4 or more cams) (See notes 3 and 4.) 800 r/min max. at a resolution of 720 (600 r/min max. if ADV function is set for 4 or more cams) • Includes error data detection
Encoder cable extension distance		256/360 resolution 100 m max. at 330 r/min or less 52 m max. at 331 to 1200 r/min (331 to 900 r/min if ADV function is set for 4 or more cams) 12 m max. at 1201 to 1600 r/min (901 to 1200 r/min if ADV function is set for 4 or more cams) 720 resolution 100 m max. at 330 r/min or less 52 m max. at 331 to 600 r/min (331 to 450 r/min if ADV function is set for 4 or more cams) 12 m max. at 601 to 800 r/min (451 to 600 r/min if ADV function is set for 4 or more cams)
Output response time		0.3 ms max.
Insulation resistance		100 MΩ min. (at 500 VDC) between current-carrying terminals and exposed non-current-carrying metal parts, between all current-carrying parts and the USB connector
Dielectric strength		1000 VAC, 50/60 Hz for 1 min between current-carrying terminals and exposed non-current-carrying metal parts 500 VAC, 50/60 Hz for 1 min between current-carrying section and USB connector, and between current-carrying terminals and non-current-carrying metal part of output connector
Impulse withstand voltage		1 kV between power terminals 1.5 kV between current-carrying terminals and exposed non-current-carrying metal parts
Noise immunity		±480 V between power terminals, ±600 V between input terminals Square-wave noise by noise simulator (pulse width: 100 ns/1 μs, 1-ns rise)
Static immunity		8 kV (malfunction), 15 kV (destruction)
Vibration resistance	Destruction	10 to 55 Hz with 0.75-mm single amplitude each in 3 directions for 2 hours each
	Malfunction	10 to 55 Hz with 0.5-mm single amplitude each in 3 directions for 10 minutes each
Shock resistance	Destruction	300 m/s ² 3 times each in 6 directions
	Malfunction	200 m/s ² 3 times each in 6 directions
Approved safety standards		cULus (Listing): UL508/CSA C22.2 No. 14
EMC		(EMI) EN61326 Emission Enclosure: EN55011 Group1 Class A (EMS) EN61326 Immunity ESD: EN61000-4-2: 4 kV contact discharge 8 kV air discharge Immunity RF-interference: EN61000-4-3: 10 V/m (Amplitude-modulated, 80 MHz to 1 GHz) 10 V/m (Pulse-modulated, 900 MHz ±5 MHz) Immunity Conducted Disturbance EN61000-4-6: 10 V (0.15 to 80 MHz) Immunity Burst: EN61000-4-4: 2 kV for power-line 1 kV for I/O signal-line Immunity Surge: EN61000-4-5: 1 kV line to line (power line) 2 kV line to ground (power line)
Weight		Approx. 300 g (Cam Positioner main unit only)

- Note:**
1. Cam output precision, however, is 2° max. for Encoder with 256 resolution (P/R).
 2. Although 32-output Models can have 10 steps set for any one output, there must be no more than 160 steps total set for all cam outputs.
 3. The maximum is 1000 r/min when an E6CP-AG5C-C Encoder is connected.
 4. ADV stands for Advance Angle Compensation.

■ Functions

Item	H8PS-8□	H8PS-16□	H8PS-32□
Encoder rotation direction switching	Encoder data can be set with a DIP switch to forward (CW) or reverse (CCW) direction.		
Encoder origin designation	The present display angular position can be set to 0° (origin) by pressing the ORIGIN Key on the front panel.	The present display angular position can be set to 0° (origin) by using the origin input terminal or the ORIGIN Key on the front panel. Note: All banks use the same origin.	
Angle display switch	Converts the Absolute Encoder value display from 256 divisions/revolution to 360°/revolution.		
Rotation display monitor	Graphically displays the Encoder rotational angular position.		
Teaching function	Sets the cam output ON/OFF angle based on actual machine (Encoder) operation.		
Pulse output	Outputs a preset number of pulses per Encoder rotation. It also sets the pulse output start angle.		
Switching the angle and speed displays	Displays both the present angular position and the number of Encoder revolutions (speed) in Run Mode. Switches back and forth between the main display showing the present angular position with the sub-display showing the speed and the main display showing the speed with the sub-display showing the present angular position.		
Bank function	---	Enables the entire cam program to be changed at one time by switching banks (0 to 7). The bank that is running can be switched using the bank input terminal or the BANK Key on the front panel. Also enables programs to be copied between banks.	
Advance angle compensation (ADV) function	Automatically advances the ON/OFF angle of cam outputs in proportion to machine (encoder) speed to compensate for the delay in timing of ON/OFF operation. ADV values can be set individually for 7 cam outputs.		
Speed alarm output	A specified cam output can be used as an Encoder speed alarm output. The function can output upper and lower limit speed alarms.		
All protection function	Disables all key and switch operations in Run Mode to prevent incorrect or unauthorized operation.		
Cam protection function	Prohibits program changes at the cam output level. Any cam numbers can be protected.		
Step number limit	Limits the number of steps that can be set per cam output. Prohibits incorrect operations by adding to the program.		
Output prohibit	---	The start input can be turned OFF in Run or Test Mode to prohibit cam output. Note: Use this function carefully for the application because no cam outputs are provided when the start input is turned OFF.	
Support Software settings	---	Programs can be uploaded or downloaded easily by connecting a personal computer to the Cam Positioner using a USB Cable (Recommended USB Cables: ELECOM CO.Ltd. U2C-MF20BK) and the Support Software (H8PS-SOFT-V1, sold separately).	

Connections

Terminal Arrangement

H8PS-8□ (8-output Models)	H8PS-16□/-32□ (16-/32-output Models)
<p>NPN Output, Flush Mounting H8PS-8□</p> <p>(Rear view)</p>	<p>NPN Output, Flush Mounting H8PS-16□/-32□</p> <p>(Rear view)</p>
<p>NPN Output, Surface Mounting H8PS-8□F</p> <p>(Front view)</p>	<p>NPN Output, Surface Mounting H8PS-16□F/-32□F</p> <p>(Front view)</p>
<p>PNP Output, Flush Mounting H8PS-8□P</p> <p>(Rear view)</p> <p>Note: The VS terminal is not internally connected to the positive (+) power supply terminal.</p>	<p>PNP Output, Flush Mounting H8PS-16□P/-32□P</p> <p>(Rear view)</p> <p>Note: The VS terminal is not internally connected to the positive (+) power supply terminal.</p>
<p>PNP Output, Surface Mounting H8PS-8□FP</p> <p>(Front view)</p> <p>Note: The VS terminal is not internally connected to the positive (+) power supply terminal.</p>	<p>PNP Output, Surface Mounting H8PS-16□FP/-32□FP</p> <p>(Front view)</p> <p>Note: The VS terminal is not internally connected to the positive (+) power supply terminal.</p>

Note: For PNP output models, the VS terminal and power supply terminals are not connected internally.

Output Cable Connections (16-/32-output Models Only)

Flush Mounting Models

Output Connector 1 (CN1) Output Connector 2 (CN2) (See note.)

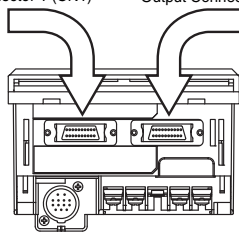

(Bottom view)

Surface Mounting Models

Output Connector 1 (CN1) Output Connector 2 (CN2) (See note.)

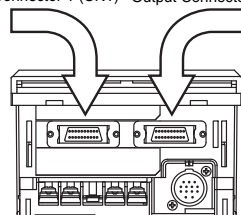

(Bottom view)

Output Connector	Output signals
Output Connector 1 (CN1)	Cam 1 to Cam 16, COM, Vs
Output Connector 2 (CN2) (See note.)	Cam 17 to Cam 32, COM, Vs

Note: The 16-output Models do not have CN2 Connectors.

1. E5ZE-CBL200 Connector-type Output Cable (Order Separately) Connections

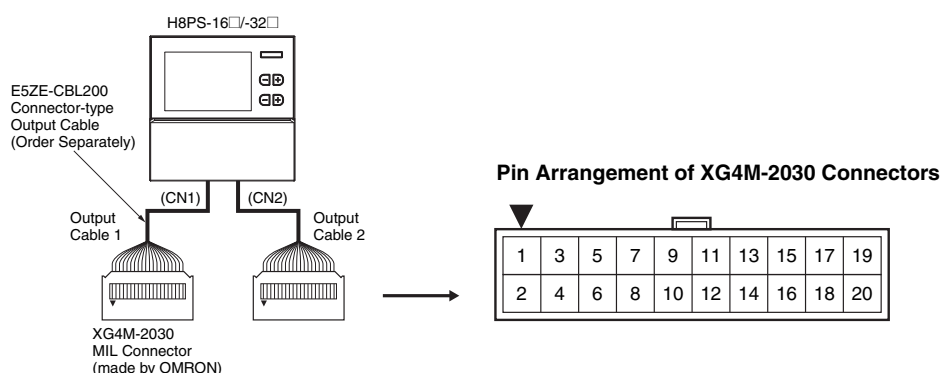

Output Cable 1 Wiring Table

Outputs	Connector pin No.	Outputs	Connector pin No.
Cam 1	20	Cam 9	19
Cam 2	18	Cam 10	17
Cam 3	16	Cam 11	15
Cam 4	14	Cam 12	13
Cam 5	12	Cam 13	11
Cam 6	10	Cam 14	9
Cam 7	8	Cam 15	7
Cam 8	6	Cam 16	5
COM	4	COM	3
Vs	2	Vs	1

Output Cable 2 Wiring Table

Outputs	Connector pin No.	Outputs	Connector pin No.
Cam 17	20	Cam 25	19
Cam 18	18	Cam 26	17
Cam 19	16	Cam 27	15
Cam 20	14	Cam 28	13
Cam 21	12	Cam 29	11
Cam 22	10	Cam 30	9
Cam 23	8	Cam 31	7
Cam 24	6	Cam 32	5
COM	4	COM	3
Vs	2	Vs	1

- Note:**
1. The COM pins in the output connectors are connected inside the Cam Positioner to the negative terminal of the 24-VDC power supply input.
 2. The Vs pins in the output connectors are connected inside the Cam Positioner to the Vs terminal.
 3. The Vs pins in the output connectors are not used on models with NPN outputs.
 4. The COM pins in output connector 1 and output connector 2 are connected to each other inside the Cam Positioner. The Vs pins in output connector 1 and output connector 2 are also connected to each other inside the Cam Positioner.

Using Connector-Terminal Block Conversion Units

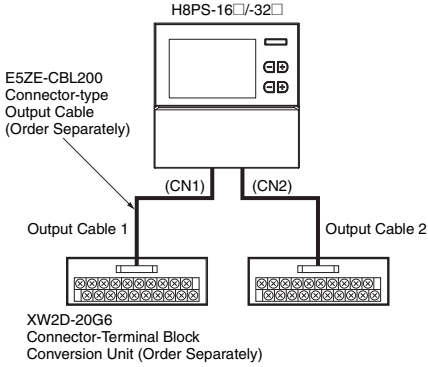

Terminal Arrangement of the XW2D-20G6 Connector-Terminal Block Conversion Unit

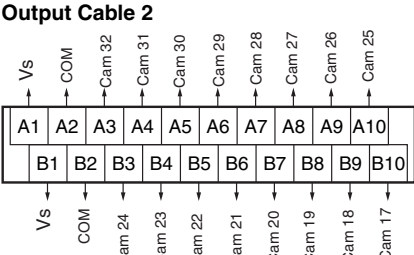
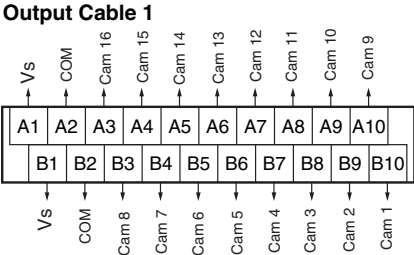

2. Y92S-41-200 Discrete Wire Output Cable (Order Separately) Connections

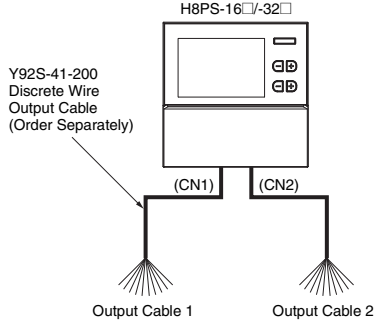

Output Cable 1 Wiring Table

Outputs	Cable color	Marks	Marking color	Outputs	Cable color	Marks	Marking color
Cam 1	Orange	■	Black	Cam 9	Orange	■	Red
Cam 2	Gray	■	Black	Cam 10	Gray	■	Red
Cam 3	White	■	Black	Cam 11	White	■	Red
Cam 4	Yellow	■	Black	Cam 12	Yellow	■	Red
Cam 5	Pink	■	Black	Cam 13	Pink	■	Red
Cam 6	Orange	■ ■	Black	Cam 14	Orange	■ ■	Red
Cam 7	Gray	■ ■	Black	Cam 15	Gray	■ ■	Red
Cam 8	White	■ ■	Black	Cam 16	White	■ ■	Red
COM	Yellow	■ ■	Black	COM	Yellow	■ ■	Red
Vs	Pink	■ ■	Black	Vs	Pink	■ ■	Red

Output Cable 2 Wiring Table

Outputs	Cable color	Marks	Marking color	Outputs	Cable color	Marks	Marking color
Cam 17	Orange	■	Black	Cam 25	Orange	■	Red
Cam 18	Gray	■	Black	Cam 26	Gray	■	Red
Cam 19	White	■	Black	Cam 27	White	■	Red
Cam 20	Yellow	■	Black	Cam 28	Yellow	■	Red
Cam 21	Pink	■	Black	Cam 29	Pink	■	Red
Cam 22	Orange	■ ■	Black	Cam 30	Orange	■ ■	Red
Cam 23	Gray	■ ■	Black	Cam 31	Gray	■ ■	Red
Cam 24	White	■ ■	Black	Cam 32	White	■ ■	Red
COM	Yellow	■ ■	Black	COM	Yellow	■ ■	Red
Vs	Pink	■ ■	Black	Vs	Pink	■ ■	Red

Input Connections

Only the Encoder inputs are connected with 8-output Models. The inputs are no-voltage (short-circuit or open) inputs.

No-voltage Inputs

Open Collector

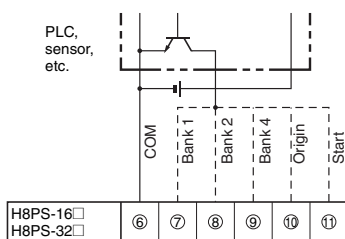

Note: Operates when the transistor turns ON.

Contact Input

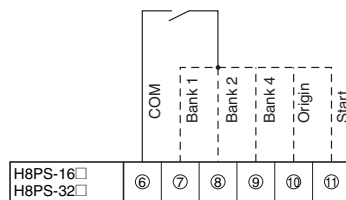

Note: Operates when the contact turns ON.

Voltage-output sensors can also be connected.

Connection Examples

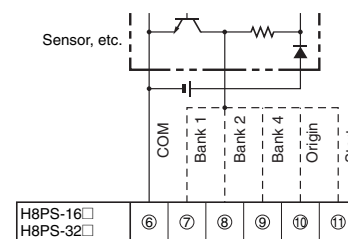

Note: Operates when the transistor turns ON.

No-voltage Input Signal Levels

No-contact inputs	Short-circuit level for transistor ON
	<ul style="list-style-type: none"> Residual voltage: 2 V max. Impedance when ON: 1 kΩ max. (The leakage current is approx. 2 mA when the impedance is 0 Ω.)
Contact inputs	Open level for transistor OFF
	<ul style="list-style-type: none"> Impedance when OFF: 100 kΩ min.
Use a contact that can adequately switch 2 mA at 5 V.	

Note: Use a maximum DC power supply of 30 V.

Output Connections

Note: Internal circuit damage may result from a short circuit in the load.

NPN Output Models

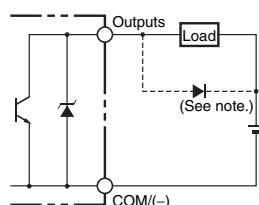

Note: Always connect a diode to absorb counter-electromotive force when connecting an inductive load.

Item	Cam outputs, RUN output	Pulse output
Output method	NPN open collector	
Dielectric strength	30 VDC	
Rated current	100 mA (See note.)	30 mA
Residual voltage	2 VDC max.	0.5 VDC max.
Leakage current	100 μ A max.	5 μ A max.

Note: Do not exceed 1.6 A total for all cam outputs and the RUN output.

PNP Output Models

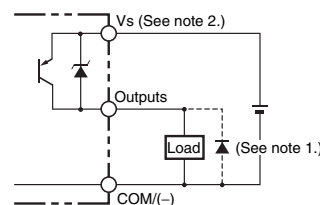

Note: 1. Always connect a diode to absorb counter-electromotive force when connecting an inductive load.
2. The VS terminal and power supply terminals are not connected internally.

Item	Cam outputs, RUN output	Pulse output
Output method	PNP open collector	
Dielectric strength	8-output Models: 30 VDC 16-/32-output Models: 26.4 VDC	
Rated current	100 mA (See note.)	30 mA
Residual voltage	2 VDC max.	
Leakage current	100 μ A max.	

Note: Do not exceed 1.6 A total for all cam outputs and the RUN output.

Operating Mode

■ Functions

The H8PS Cam Positioner receives angle signal inputs from the Dedicated Absolute Encoder and outputs the preset ON/OFF angles as cam outputs.

Program Examples

1. H8PS-8□ (8-output Models)

Cam output (cam number)	Step 0		Step 1		...	Step 9	
	ON angle	OFF angle	ON angle	OFF angle		ON angle	OFF angle
1	45°	90°	135°	225°		270°	315°
2	0°	90°	135°	180°		---	---
⋮							
8	90°	225°	270°	285°		315°	345°

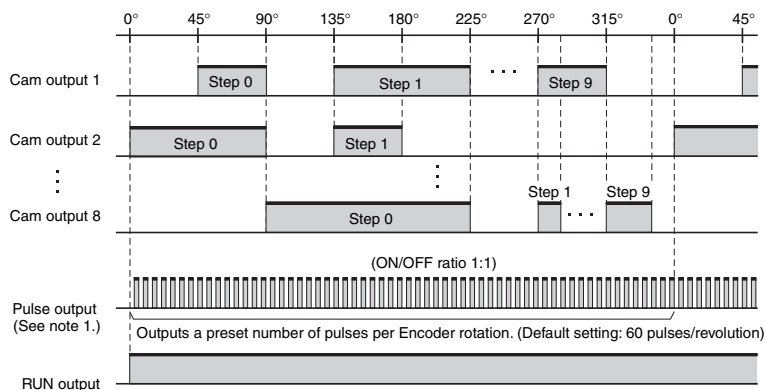

- Note 1:** The number of pulses per Encoder rotation and the pulse output start angle can be set.
- Note 2:** With counterclockwise rotation (359°, 358° ... 1°, 0°), step 0 for cam output 1 turns ON at 89° and OFF at 44° at in the diagram.

2. H8PS-16□ /-32□ (16-/32-output Models)

Cam Program (Bank No. 7)

Cam Program (Bank No. 2)

Cam Program (Bank No. 1)

Cam Program (Bank No. 0)

Cam output (cam number)	Step 0		Step 1		...	Step 9	
	ON angle	OFF angle	ON angle	OFF angle		ON angle	OFF angle
1	45°	90°	135°	225°		270°	315°
2	0°	90°	135°	180°		---	---
⋮							
32	90°	225°	270°	285°		315°	345°

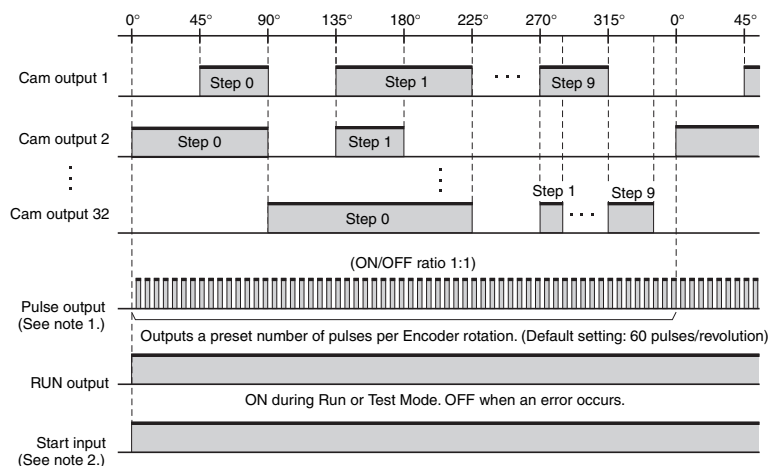

- Note 1:** The number of pulses per Encoder rotation and the pulse output start angle can be set.
- Note 2:** Be sure to turn ON the start input in Run and Test modes. Otherwise, there will be no outputs (output prohibited), including the cam outputs, pulse output, and RUN output.
- Note 3:** With counterclockwise rotation (359°, 358° ... 1°, 0°), step 0 for cam output 1 turns ON at 89° and OFF at 44° in the diagram.

Note: The entire cam program can be changed at one time with 16- and 32-output Models with the bank function (banks 0 to 7). For details on the procedure for switching banks, refer to page 29.

Nomenclature

Displays

8-output Models

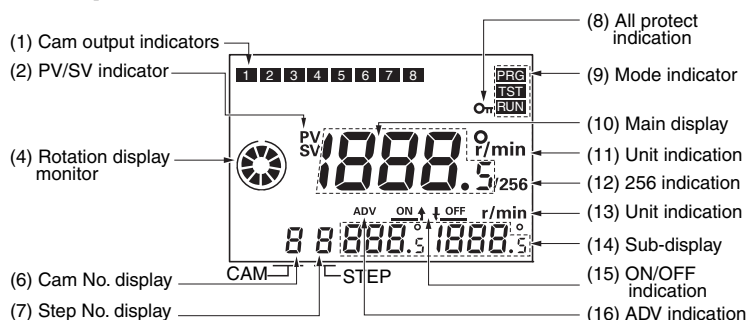

16-/32-output Models

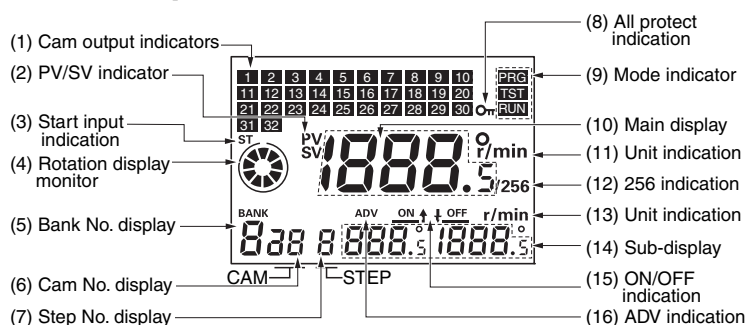

Display Details

No.	Display color	Description
(1)	Orange	Lit while cam outputs are ON.
(2)	Red	PV: Lit while the present angular position or speed is displayed in main display. SV: Lit while the setting value is displayed in main display.
(3)	Orange	Lit while the start input is ON in Run or Test Mode. Not lit when an error occurs.
(4)	Orange	Displays Encoder present angular position, direction, and speed guidelines.
(5)	Green	Displays the bank number that is running in Run or Test Mode and the bank number selected in Programming Mode.
(6)	Green	Displays the cam number for the angle setting displayed on sub-display.
(7)	Green	Displays the step number for the angle setting displayed on sub-display.
(8)	Orange	Lit while the All Protection function is enabled.
(9)	Orange	The indicator for the selected mode is lit. PRG: Programming Mode TST: Test Mode RUN: Run Mode
(10)	Red	Displays the present angular position or the speed and settings being made.
(11)	Red	Displays units for the angle or the speed displayed on main display.
(12)	Red	Lit while using an Encoder with a resolution of 256 if 256° display is selected.
(13)	Green	Displays units for the angle or the speed displayed on sub-display.
(14)	Green	Displays the speed or the ON/OFF angle settings.
(15)	Green	Indicates whether main display displays the ON or OFF angle setting.
(16)	Green	Lit while setting the Advance Angle Compensation (ADV) Function.

Operation Keys

8-output Models

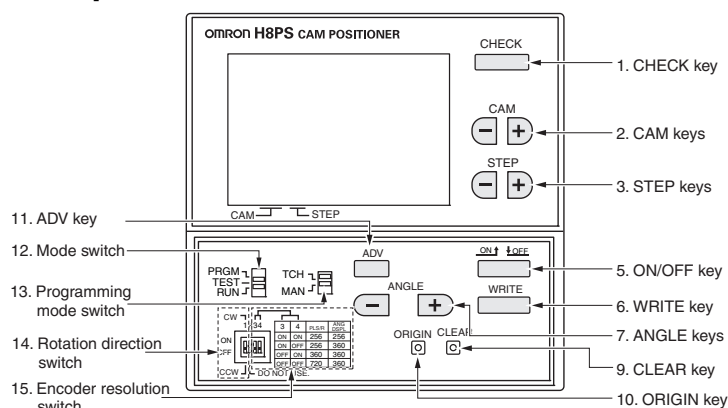

16-/32-output Models

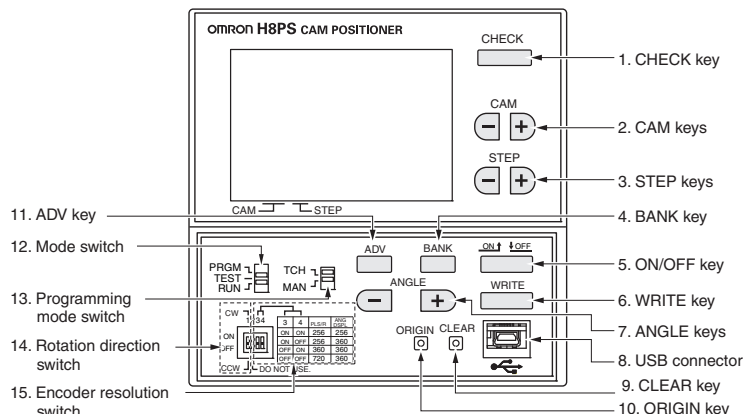

Operation Key Details

No.	Description
1	Displays program details in Run Mode.
2	Selects the cam number with [+/-] Keys.
3	Selects the step number with [+/-] Keys.
4	Selects the bank number.
5	Selects the ON angle, or OFF angle
6	Writes the set data to memory.
7	Changes the angle or other setting value with [+/-] Keys.
8	Connects the Cam Positioner to a personal computer via USB cable (order separately) for programming with the Support Software (order separately).
9	Moves to the screen for clearing settings
10	Designates the current angle of the machine (Encoder) as the origin (0°).
11	Programming or Test Mode: Press to shift to the ADV function setting screen. Programming Mode: Press and hold at least 3 s to shift to the Function Setting Mode. Run Mode: Press and hold at least 5 s to enable/disable the All Protection function.
12	Switches modes. Programming Mode (PRGM): Used to write cam programs, set the ADV function, etc. Test Mode (TEST): Used to modify settings while the Encoder is running. Run Mode (RUN): Used for normal operation and to check the cam program.
13	Select the method used for programming cams. Teaching: ON/OFF Angles can be set based on actual machine (Encoder) operation. Manual: ANGLE Keys can be used to set ON/OFF angles.
14	Sets the H8PS rotation direction (rotation display monitor, etc.) to the machine (Encoder) rotation direction.
15	Sets the resolution of the connected Encoder. Also sets the unit for angle display when using an Encoder with a resolution of 256.

Dimensions

Note: All units are in millimeters unless otherwise indicated.

■ Main Unit

Cam Positioners

Flush Mounting Models H8PS-8B□ (8-output Models)

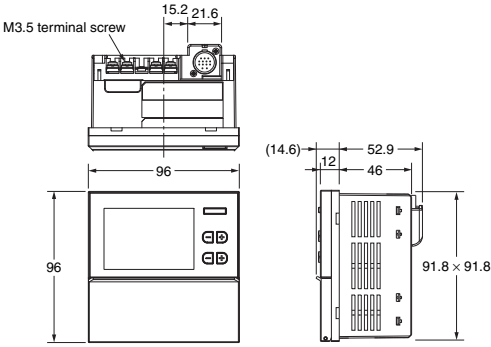

Panel Cutout (according to DIN 43700)

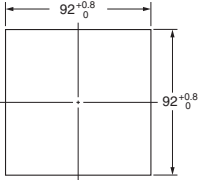

Note: Mounting panel thickness must be 1 to 5 mm.

Flush mounting

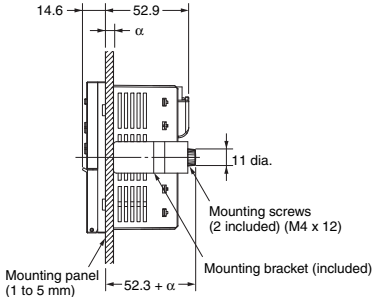

Note: An 8-output Model is shown in the above diagrams. The Encoder is connected from the bottom with 16-/32-output Models.

H8PS-16B□ (16-output Models) H8PS-32B□ (32-output Models)

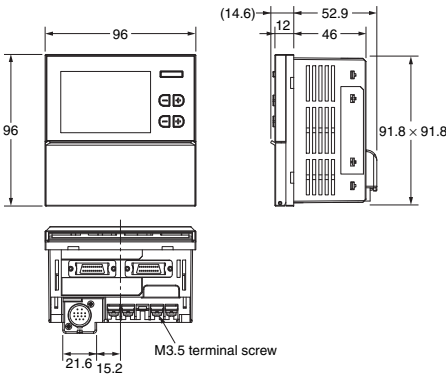

Surface Mounting Models H8PS-8BF□ (8-output Models)

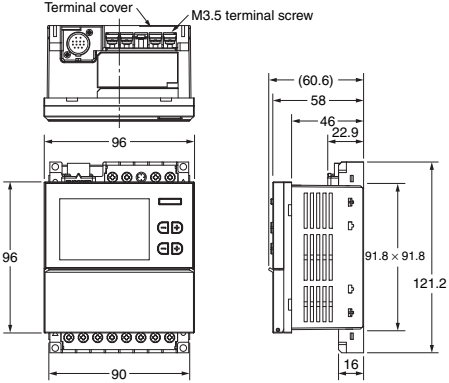
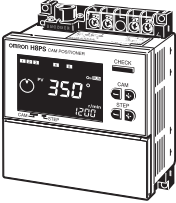

Mounting holes

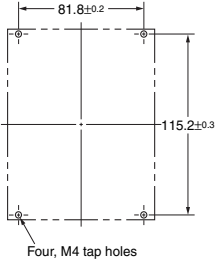

Surface Mounting

Track Mounting

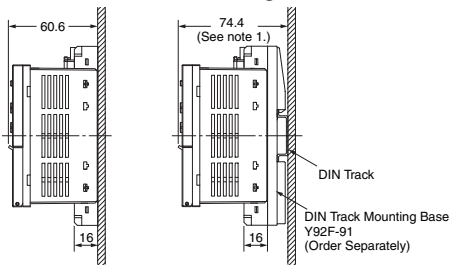

H8PS-16BF□ (16-output Models) H8PS-32BF□ (32-output Models)

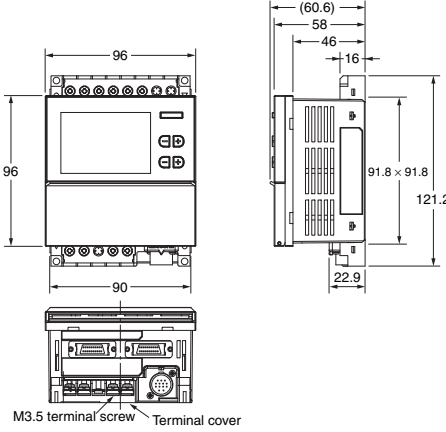
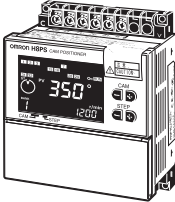

Note: 1. These dimensions vary with the kind of DIN track (reference value).
2. An 8-output Model is shown in the above diagrams. The Encoder is connected from the bottom with 16-/32-output Models.

Encoder Connecting Direction

H8PS-8B

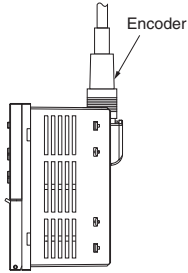

H8PS-8BF

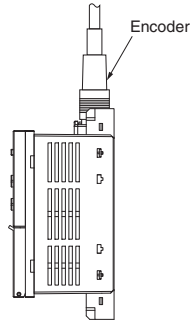

H8PS-16B
H8PS-32B

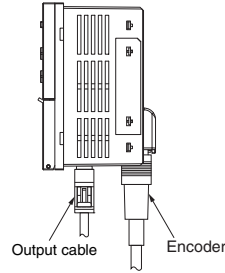

H8PS-16BF
H8PS-32BF

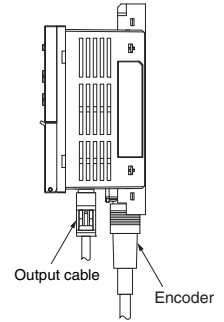

Accessories (Order Separately)

Parallel Input Adapters

Y92C-30

This Adapter enables two H8PS Cam Positioners to share signals from an Encoder.

Note: H8PS has been improved in 2004 April.
Do not mix old and new model with Y92C-30.
When you use 2 x H8PS, please use by "Old & Old" or "New & New" models.

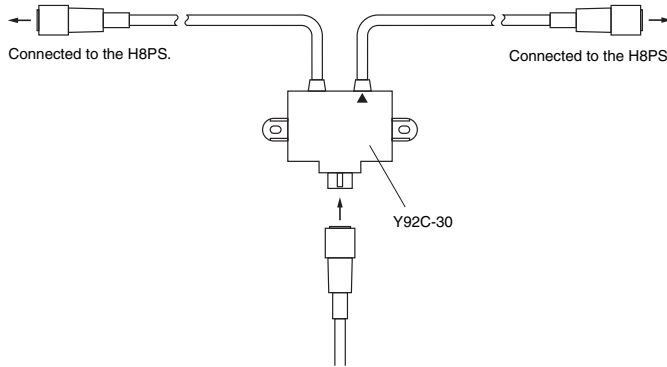
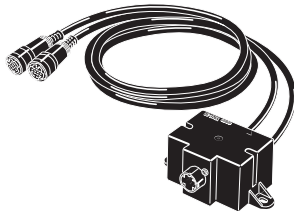

Use the cable marked with a triangle when connecting only one H8PS Cam Positioner to the Parallel Input Adapter.

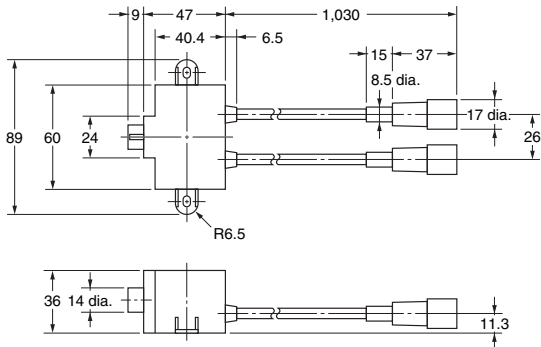

Panel Surface Mounting

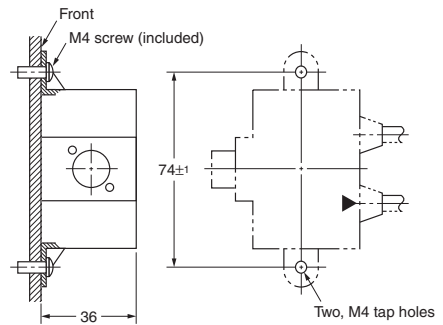

Panel Back Mounting

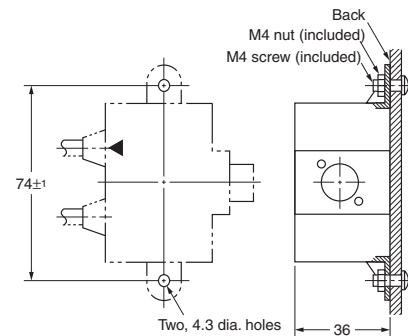

■ Accessories (Order Separately)

Watertight Cover

Y92A-96N

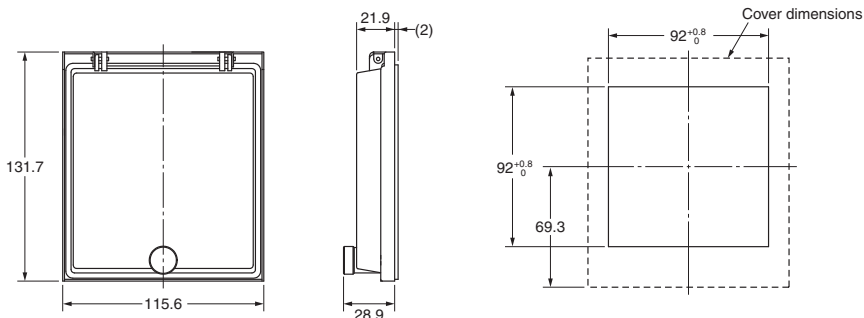
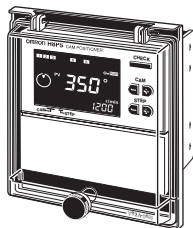

Use for flush mounting when waterproofing is required. The Y96A-96N conforms to IP66 and NEMA4 (for indoor use) standards for waterproofing. The operating environment may cause the waterproof packing to deteriorate, shrink, or harden. Therefore, it is recommended that the packing be replaced regularly.

Protective Cover

Y92A-96B

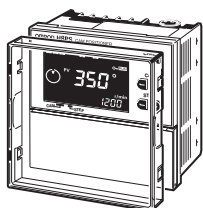

A hardened Y92A-96B Protective Cover is available. Use it for the following:

- To protect the front panel from dust and dirt.
- To prevent the set value from being altered due to accidental contact with the keys or switches.

DIN Track Mounting Base

Y92F-91

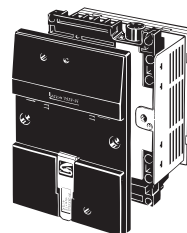

Discrete Wire Output Cable

Y92S-41-200

Cable length: 2 m

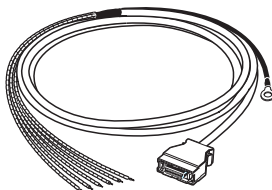

Connector-type Output Cable

E5ZE-CBL200

Cable length: 2 m

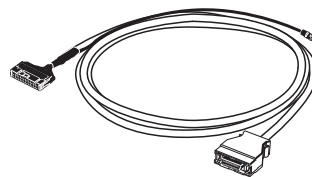

Mounting Track

PFP-100N
PFP-50N

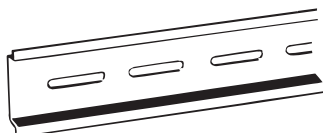

PFP-100N2

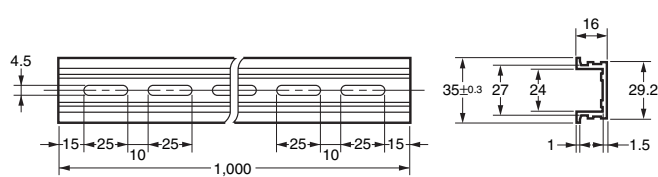
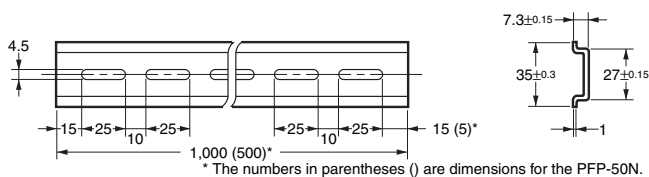
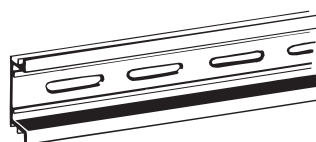

*The numbers in parentheses () are dimensions for the PFP-50N.

End Plate

PFP-M

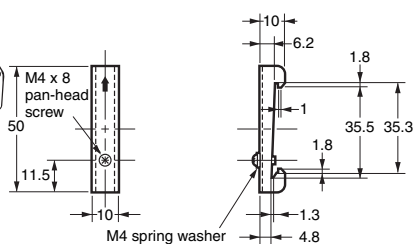
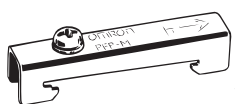

Spacer

PFP-S

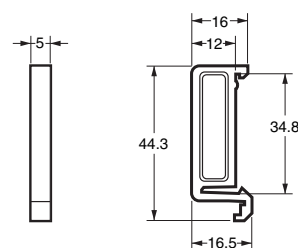
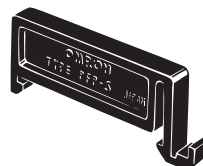

E6CP-A/E6C3-A/E6F-A Rotary Encoders (Absolute)

- Combining this Encoder with an H8PS Cam Positioner enables high-precision detection of the operation timing of various automatic machines.
- The E6CP-A is a low-cost, money-saving Encoder.
- The standard E6C3-A is well suited to environments subject to water and oil.
- The standard E6F-A is a rigid type that is compatible with high shaft-tolerance applications as well as environments subject to water and oil.

Note: Refer to the relevant datasheet for details.



Ratings and Characteristics

Item	E6CP-AG5C-C	E6C3-AG5C-C	E6F-AG5C-C
Rated supply voltage	12 VDC -10% to 24 VDC +15%, ripple (p-p) 5% max.		
Current consumption (See note 1.)	70 mA max.		60 mA max.
Resolution (pulses per rotation)	256 (8-bit)	256 (8-bit), 360 (9-bit), or 720 (10-bit)	
Output code	Gray binary		
Output configuration	NPN open-collector output		
Output capacity	Applied voltage: 28 VDC max. Sink current: 16 mA max. Residual voltage: 0.4 V max. (sink current at 16 mA)	Applied voltage: 30 VDC max. Sink current: 35 mA max. Residual voltage: 0.4 V max. (sink current at 35 mA)	
Logic	Negative logic (H = 0, L = 1)		
Accuracy	Within $\pm 1^\circ$		
Rotation direction	Clockwise (viewed from the shaft) for output code increment		
Rise and fall times of output	1.0 μ s max. (control output voltage: 16 V; load resistance: 1 k Ω ; output cord: 2 m max.)	1.0 μ s max. (control output voltage: 5 V; load resistance: 1 k Ω ; output cord: 2 m max.)	
Starting torque	0.98 m N·m max.	10 m N·m max. (at room temperature), 30 m N·m max. (at low temperature)	9.8 m N·m max. (at room temperature), 14.7 m N·m max. (at low temperature)
Moment of inertia	1 $\times 10^{-6}$ kg·m ² max.	2.3 $\times 10^{-6}$ kg·m ² max.	1.5 $\times 10^{-6}$ kg·m ² max.
Shaft-load tolerance	Radial	29.4 N	80 N
	Thrust	19.6 N	50 N
Max. permissible rotation	1000 r/min	5000 r/min	
Ambient temperature	-10 to 55°C (with no icing)		-10 to 70°C (with no icing)
Storage temperature	-25 to 85°C (with no icing)		-25 to 80°C (with no icing)
Ambient humidity	35% to 85% (with no condensation)		
Degree of protection	IEC standard IP50	IEC standard IP65 (JEM standard IP65f) (See note 2.)	IEC standard IP65 (JEM standard IP65f)
Insulation resistance	200 M Ω min. (at 500 VDC) between charged parts and the case		
Dielectric strength	500 VAC, 50/60 Hz for 1 min between charged parts and the case		
Vibration resistance	Destruction: 10 to 55 Hz, 1.5-mm double amplitude for 2 hr each in X, Y, and Z directions	Destruction: 10 to 500 Hz, 2-mm double amplitude, 150 m/s ² 3 times each in X, Y, and Z directions, 11-min sweep time	Destruction: 10 to 500 Hz, 1.5-mm double amplitude 3 times each in X, Y, and Z directions, 11-min sweep time
Shock resistance	Destruction: 1000 m/s ² 3 times each in X, Y, and Z directions		
Weight	Approx. 200 g (with 2-m cord)	Approx. 300 g (with 1-m cord)	Approx. 500 g (with 2-m cord)
Datasheet Cat. No.	---	F058	E283

Note: 1. The following inrush currents flow when the power is turned ON.

- E6CP-AG5C-C: Approx. 8 A (time: approx. 0.3 ms),
- E6C3-AG5C-C: Approx. 6 A (time: approx. 0.8 ms),
- E6F-AG5C-C: Approx. 9 A (time: approx. 5 μ s)

2. JEM1030: Applicable as of 1991

Dimensions

Note: All units are in millimeters unless otherwise indicated.

E6CP-AG5C-C



Note: Order the E69-C06B Coupling separately.

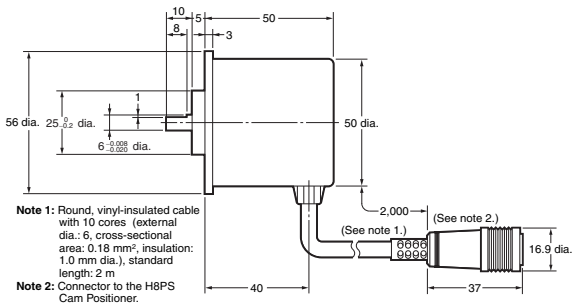
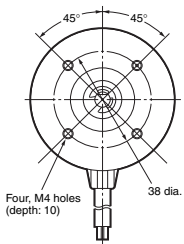

Note 1: Round, vinyl-insulated cable with 10 cores (external dia.: 6, cross-sectional area: 0.18 mm², insulation: 1.0 mm dia.), standard length: 2 m
Note 2: Connector to the H8PS Cam Positioner.

Accessory Mounting Bracket (Included)

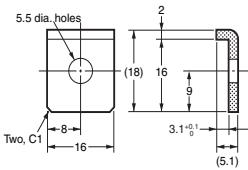

Bracket Mounting Diagram

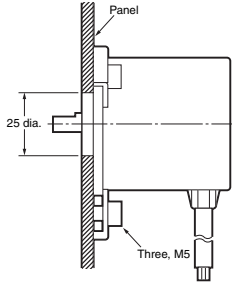
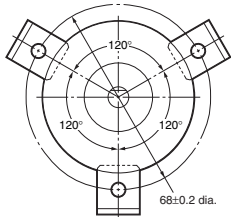

E6C3-AG5C-C



Note: Order the E69-C08B Coupling separately.

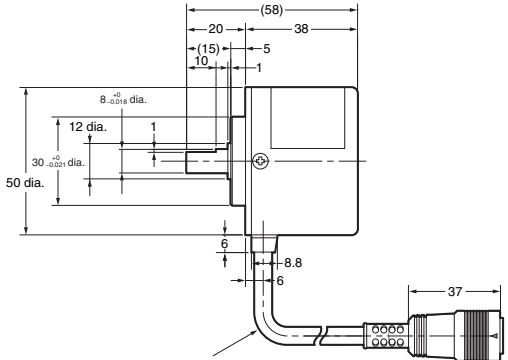
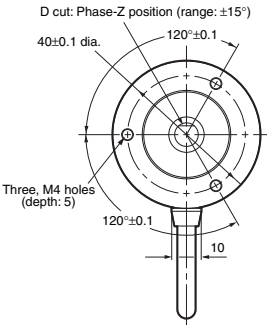

Oil-resistant, shield PVC-insulated cable with 12 cores (external dia.: 6, cross-sectional area: 0.2 mm², insulation: 1.1 mm dia.), standard length: 1 m or 2 m

E6F-AG5C-C

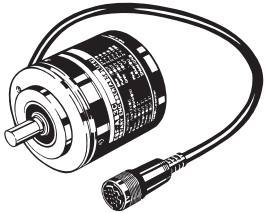

Note: Order the E69-C10B Coupling separately.

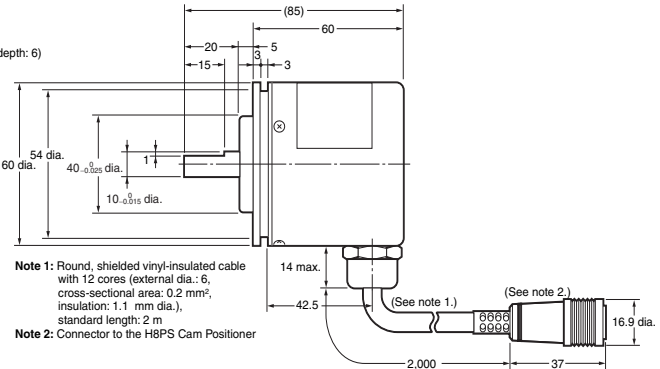
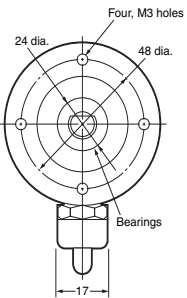

Note 1: Round, shielded vinyl-insulated cable with 12 cores (external dia.: 6, cross-sectional area: 0.2 mm², insulation: 1.1 mm dia.), standard length: 2 m
Note 2: Connector to the H8PS Cam Positioner

Accessory Mounting Bracket (included)

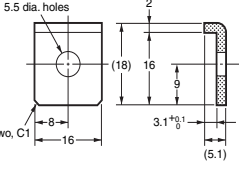

Bracket Mounting Diagram

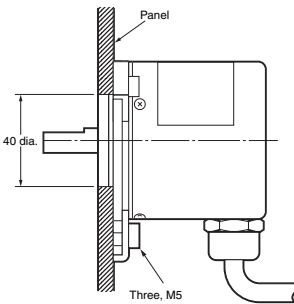
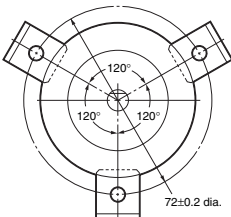

Accessories (Order Separately)

E69-C06B Shaft Coupling (for the E6CP)

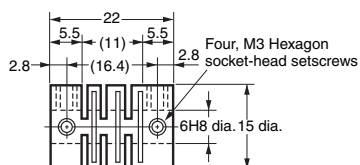

Note: The material is fiber-glass-reinforced polybutylene terephthalate resin (PBT).

E69-C08B Shaft Coupling (for the E6C3)

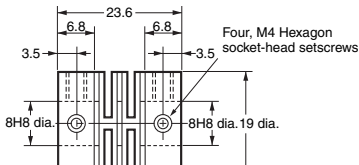

Note: The material is fiber-glass-reinforced polybutylene terephthalate resin (PBT).

E69-C10B Shaft Coupling (for the E6F)

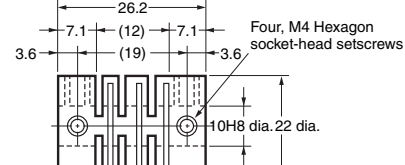

Note: The material is fiber-glass-reinforced polybutylene terephthalate resin (PBT).

E69-DF5 Extension Cable

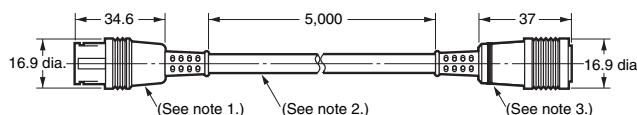
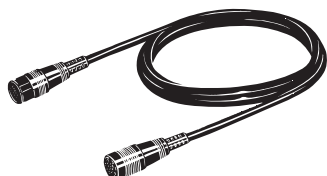

Note 1: E6F-AG5C-C, E6CP-AG5C-C, and E6C3-AG5C-C Connectors for the H8PS.

Note 2: 6-dia., 12-core shielded cable (cross-sectional area: 0.2 mm², insulation: 1.1 mm dia.), standard length: 5 m

Note 3: Connected to the H8PS Cam Positioner.

Note: Refer to *Characteristics* on page 4 for the maximum cable length.

The following models are also available: E69-DF10 (10 m), E69-DF15 (15 m), E69-DF20 (20 m), and E69-DF98 (98 m).

Safety Precautions for Encoders

Precautions for Correct Use

- Do not subject the E6CP Encoder to oil or water.
- The Encoder consists of high-precision components. Handle it with utmost care and do not drop it, otherwise malfunctioning may result.
- When connecting the shaft of the Encoder with a chain timing belt or gear, connect the chain timing belt or gear with the shaft via a bearing or coupling as shown in the following diagram.

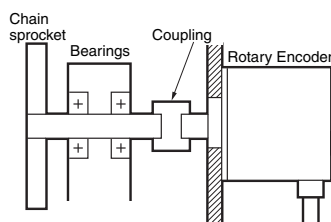

- If the decentering or declination value exceeds the tolerance, an excessive load imposed on the shaft may damage or shorten the life of the Encoder.
- Do not place excessive loads on the shaft if the shaft is connected to a gear.
- The tightening torque must not exceed the value given in the table at the right when the Rotary Encoder is mounted with screws.
- Do not pull wires with a force greater than 29.4 N while the Rotary Encoder is secured and wired.

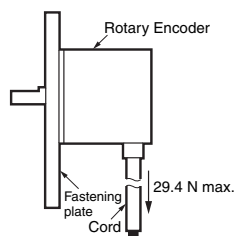

- Do not subject the shaft to shock. Therefore, do not strike the shaft or coupling with a hammer when inserting the shaft into the coupling.
- Make sure there is no foreign matter in the Connector before connecting it to the Encoder.

Mounting Procedure

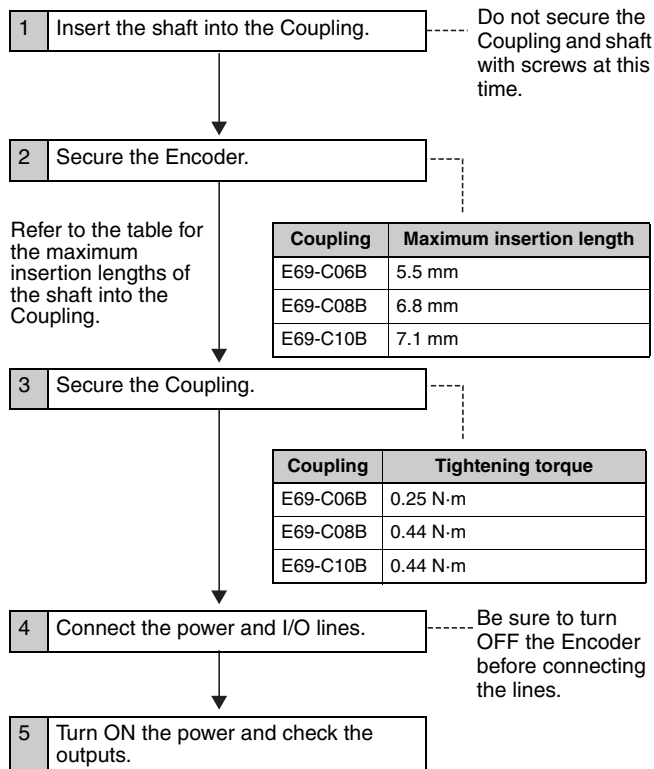

Coupling	Maximum insertion length
E69-C06B	5.5 mm
E69-C08B	6.8 mm
E69-C10B	7.1 mm

Coupling	Tightening torque
E69-C06B	0.25 N·m
E69-C08B	0.44 N·m
E69-C10B	0.44 N·m

Safety Precautions for Cam Positioners

Refer to *Safety Precautions for All Counters*.

⚠ CAUTION

Tighten terminal screws to a torque of 0.80 N·m so that they do not become loose.
Minor fires or malfunction may occasionally occur.



For 16- and 32-output Models, leave the protective label attached to the H8PS when wiring. Removing the label before wiring may occasionally result in fire if foreign matter enters the Unit.

Remove the label after the completion of wiring to ensure proper heat dissipation. Leaving the label attached may occasionally result in fire.



Do not disassemble, modify, or repair the H8PS or touch any of the internal parts. Otherwise, minor electric shock, fire, or malfunction may occasionally occur.



Do not allow metal fragments, lead wire scraps, or chips from processing during installation to fall inside the H8PS. Otherwise, minor electric shock, fire, or malfunction may occasionally occur.



Do not touch the terminals when power is being supplied. For Surface-mounting H8PS, always connect the terminal cover for after completing wiring. Otherwise, minor injury due to electric shock may occasionally occur.



■ Precautions for Safe Use

Observe the following items to ensure the safe use of this product.

Environmental Precautions

- Store the H8PS within specified ratings. If the H8PS has been stored at temperatures -10°C or lower, let it stand for 3 hours or longer at room temperature before turning ON the power supply.
- Use the H8PS within the specified ratings for operating temperature and humidity.
- Do not operate the H8PS in locations subject to sudden or extreme changes in temperature, or locations where high humidity may result in condensation.
- Do not use the H8PS in locations subject to vibrations or shock. Extended use in such locations may result in damage due to stress.
- Do not use the H8PS in locations subject to excessive dust, corrosive gas, or direct sunlight.
- Install the H8PS well away from any sources of static electricity, such as pipes transporting molding materials, powders, or liquids.
- The H8PS is not waterproof or oil resistant. Do not use it in locations subject to water or oil.
- The life expectancy of internal components may be reduced if the H8PS is mounted side-by-side.
- Do not use organic solvents (such as paint thinner or benzene), strong alkaline, or strong acids because they will damage the external finish.

Usage Precautions

- Install a switch or circuit breaker that allows the operator to immediately turn OFF the power, and label it to clearly indicate its function.
- Pay careful attention to polarity to avoid wrong connections when wiring terminals.
- Do not connect more than two crimp terminals to the same terminal.
- Use the specified wires for wiring.
Applicable Wires
AWG24 to AWG18 (cross-sectional area of 0.208 to 0.832 mm²)
Solid or twisted wires of copper
- Do not connect loads that exceed the rated output current. The output elements may be destroyed, possibly resulting in short-circuit or open-circuit faults.
- Always connect a diode to protect against counterelectromotive force when using an inductive load. Counterelectromotive force may destroy output elements, possibly resulting in short-circuit or open-circuit faults.
- Use the specified cables to connect outputs.
- Do not install input lines in the same duct or conduit as power supply or other high-voltage lines. Doing so may result in malfunction due to noise. Separate the input lines from high-voltage lines.
- Internal elements may be destroyed if a voltage outside the rated voltage is applied.
- Maintain voltage fluctuations in the power supply within the specified range.
- Use a switch, relay, or other contact so that the rated power supply voltage will be reached within 0.1 s. If the power supply voltage is not reached quickly enough, the H8PS may malfunction or outputs may be unstable.
- Do not turn OFF the power supply when changing or deleting settings. The contents of the EEPROM may be corrupted.

■ Precautions for Correct Use

- A cam output will remain ON if the set angles for two steps overlap for the same cam number.

Step 1: 120° ON → 170° OFF

Step 2: 150° ON → 210° OFF

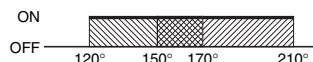

- A step will produce no output if the ON and OFF angle for the step are the same.
- The RUN output does not turn ON during programming.

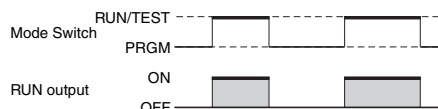

Note: The RUN output turns ON with the timing shown in the diagram, but it remains OFF when an error occurs. Thus, you can use the output as a timing signal during operation, including trial operation.

- Input signals may be accepted, not accepted, or unstable for the following times when the power supply is turned ON or OFF. Set the system to allow leeway in the timing of input signals. Approx. 1 second is required from the time the power supply is turned ON until outputs are made. Refer to the *Operation Manual* (Cat. No. Z199) for information on other timing.

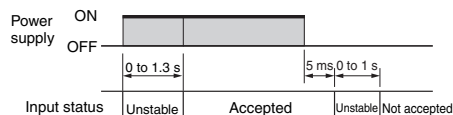

- When using 16-/32-output Modules, the operation timing of the outputs will be as shown below in relation to the ON/OFF timing of the start input. Refer to *Bank Functions (F7/F8/F9)* on page 29 when switching banks.

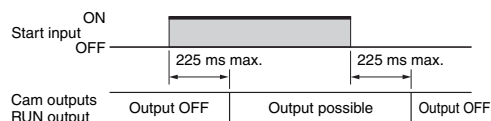

- Do not subject H8PS Connectors (outputs, Encoder) to more than 30 N of force.
- Confirm the waveform of the power supply circuit and install a surge absorber. Surge or noise applied to the power supply may destroy internal elements or cause malfunctions.
- Switch the power supply circuit with a device rated at 3.5 A or higher.
- Inrush current of approximately 3.5 A will flow for a short period of time when the power supply is turned ON. The H8PS may not start if the capacity of the power supply is not sufficient. Be sure to use a power supply with sufficient capacity.
- EEPROM is used as memory when the power is interrupted. The write life of the EEPROM is 100000 writes. The EEPROM is written when settings are changed or deleted or when the resolution is changed.
- Make sure that all settings are appropriate for the application. Unexpected operation resulting in property damage or accidents may occur if the settings are not appropriate.
- Connect all negative (-) terminals, COM terminals, and V_s terminals.
- When using the Y92C-30 Parallel Input Adapter for parallel operation, do not connect more than two H8PS Cam Positioners to the same Encoder.

Refer to the following manual for precautions in using the Cam Positioner and other information required for operation:
H8PS Cam Positioner Operation Manual (Cat. No. Z199)

Operating Procedures

■ Flow of Operation

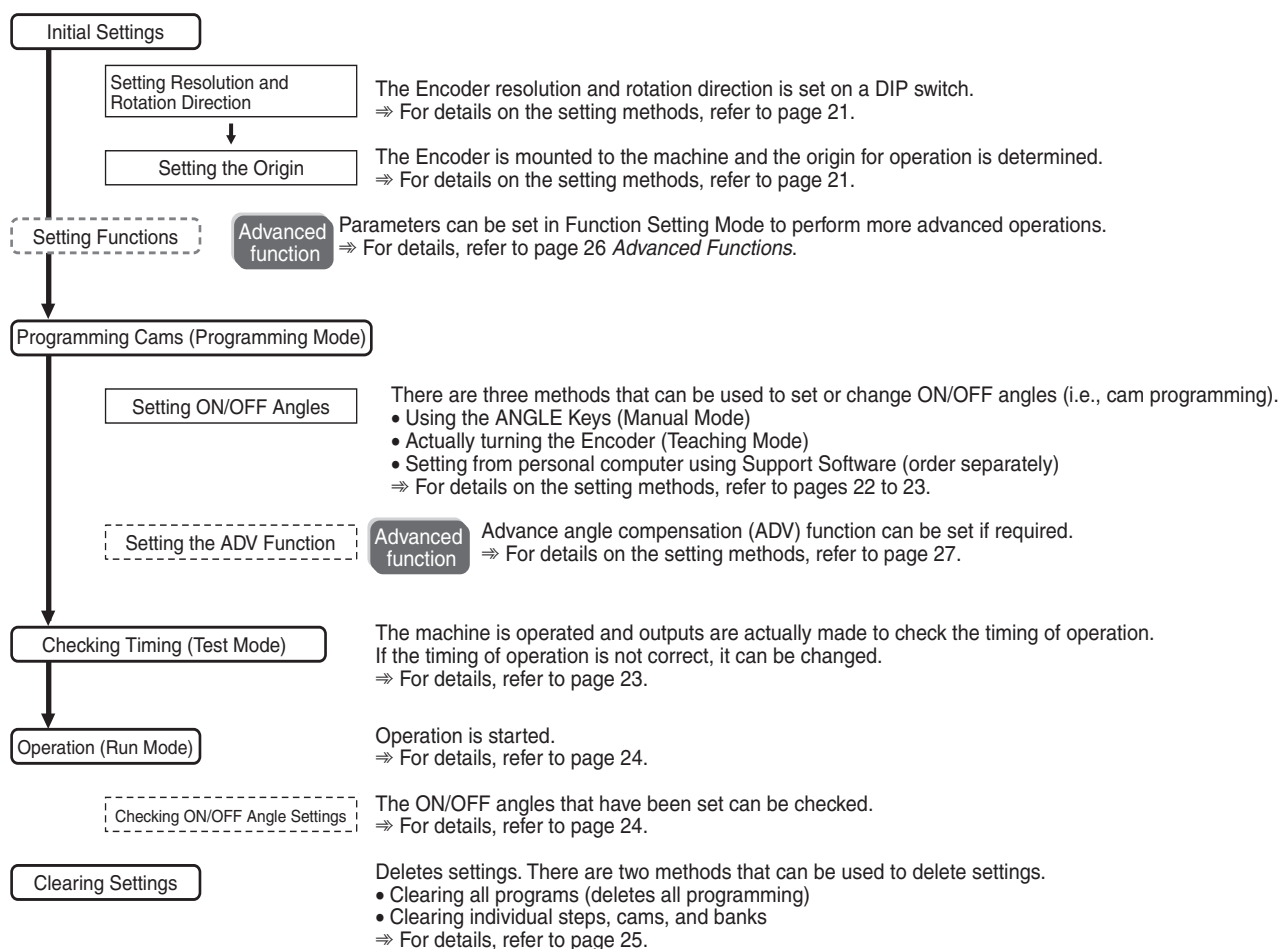

■ Settings for Basic Functions

Changing the Mode

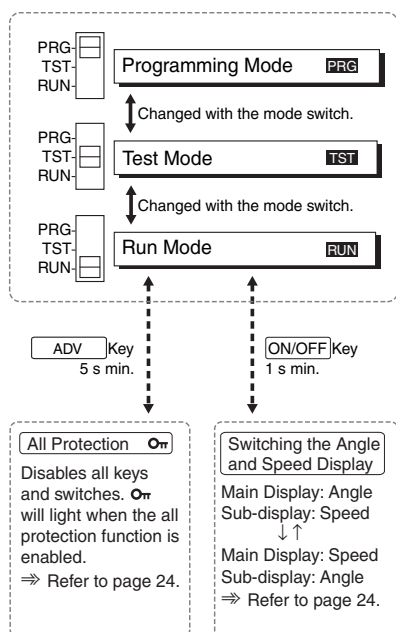

Programming Mode

Used to write cam programs, set the advance angle compensation function, etc. All outputs will remain OFF.

Test Mode

Used to write cam programs, set the advance angle compensation function, and perform other operations while actually turning ON outputs to confirm operation timing. This mode is also used to adjust settings during operation.

Run Mode

Used for normal operation. Settings, such as writing cam programs and setting the advance angle compensation function, cannot be performed.

Setting Resolution and Rotation

Direction

One of three resolutions can be selected for the Encoder connected to the H8PS: 256, 360, or 720. The resolution and display angle are set here.

Turn OFF the power supply.

Set the display angle and the Encoder resolution.

Open the front cover at the lower part of the H8PS and set pins 3 and 4 on the DIP switch.

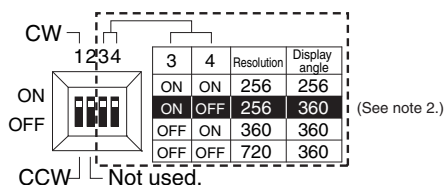

Note 1: Default settings are shown in reverse type.

Note 2: When using an Encoder with a resolution of 256, displaying 360° directly is not possible. The H8PS thus provides a convenient setting that enables converting the display and settings to 360° when using an Encoder with a resolution of 256. When using a 360° display, however, some angles will not be displayed.

Check the rotation direction of the machine (Encoder).

Turn ON the power supply.
Turn the Encoder in the actual direction of operation and confirm that the rotation display monitor turns clockwise. If the monitor turns counterclockwise, turn OFF the power supply and change pin 1 on the DIP switch to CCW.

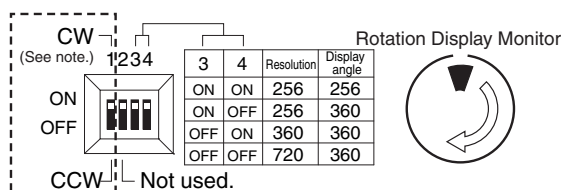

Note: Default setting.

Connect the machine (Encoder) and turn ON the power supply.

End of preparations.

Note: Changes to DIP switch settings are enabled when the power is turned ON.

Setting the Origin

The origin of the Cam Positioner is set to match the origin of the machine (Encoder). The same origin is used for all banks. (The bank function is supported only for 16-/32-output models.)

Example: Setting the Present Angular Position of 150° to 0°

Change the mode. Set the mode switch to PRGM.

Set the programming mode switch. Set the programming mode switch to TCH.

Mode	Programming mode
PRG <input type="checkbox"/>	TCH <input type="checkbox"/>
TST <input type="checkbox"/>	MAN <input type="checkbox"/>
RUN <input type="checkbox"/>	

Set the machine to its origin.

Turn the machine (Encoder) to the position of the desired origin (150° in this example).

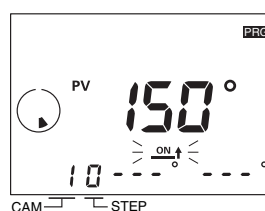

Specify the origin.

Press the **ORIGIN** Key. (See note.)
In approx. 1 s, the present angular position display will change to 0° and the previous display will return.

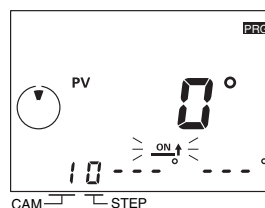

Note: With 16-/32-output models, the origin input from the terminal block can be turned ON to specify the origin.

End

Setting ON/OFF Angles in Manual Mode

ON/OFF angles can be set manually using the ANGLE Keys $\left[\begin{smallmatrix} \uparrow \\ \downarrow \end{smallmatrix} \right]$ on the front of the Cam Positioner.

Example: Setting Step 1 of Cam No. 2 to Turn ON at 28° and Turn OFF at 51°

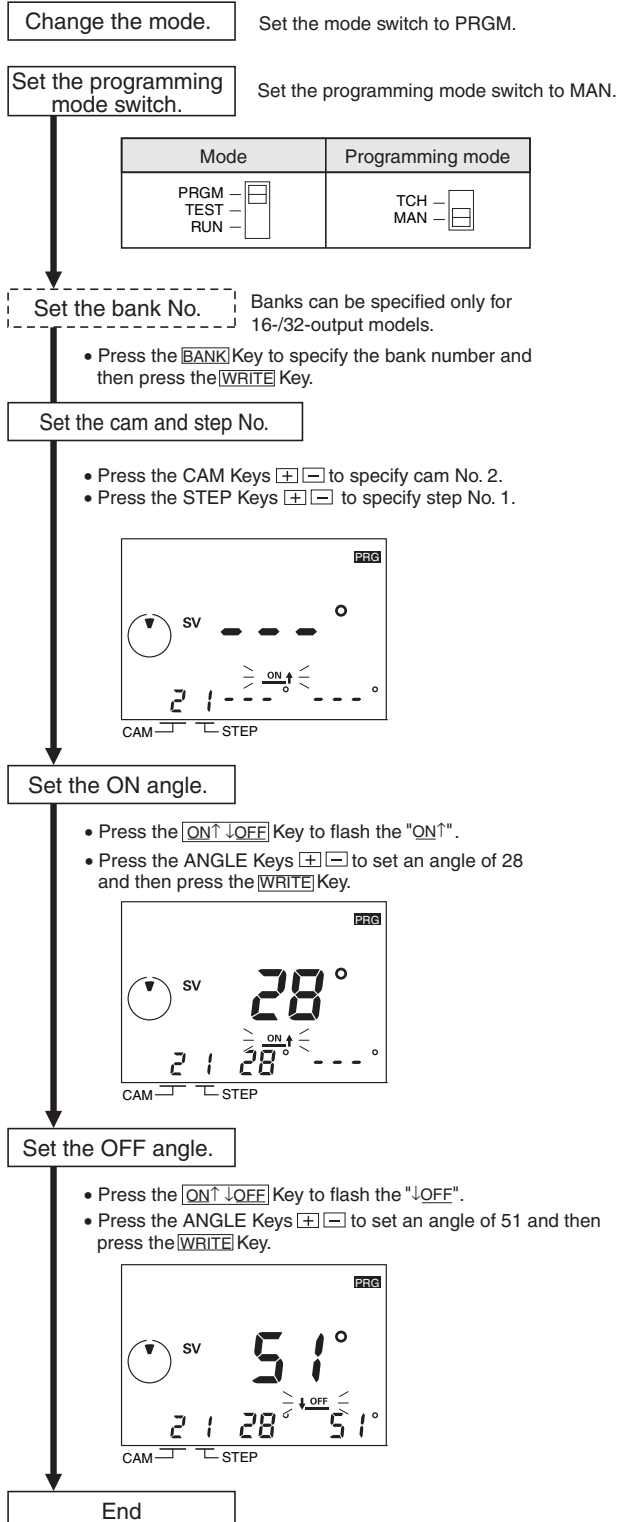

Note: Pressing the $\left[\begin{smallmatrix} \uparrow \\ \downarrow \end{smallmatrix} \right]$ or $\left[\begin{smallmatrix} \uparrow \\ \downarrow \end{smallmatrix} \right]$ Key continually will automatically increment or decrement the value. Pressing the other key during automatic increment or decrement will increase the speed.

Setting ON/OFF Angles in Teaching Mode

ON/OFF angles can be set based on actual machine (Encoder) operation.

Example: Setting the ON/OFF Angles by Teaching Step 2 of Cam No. 3

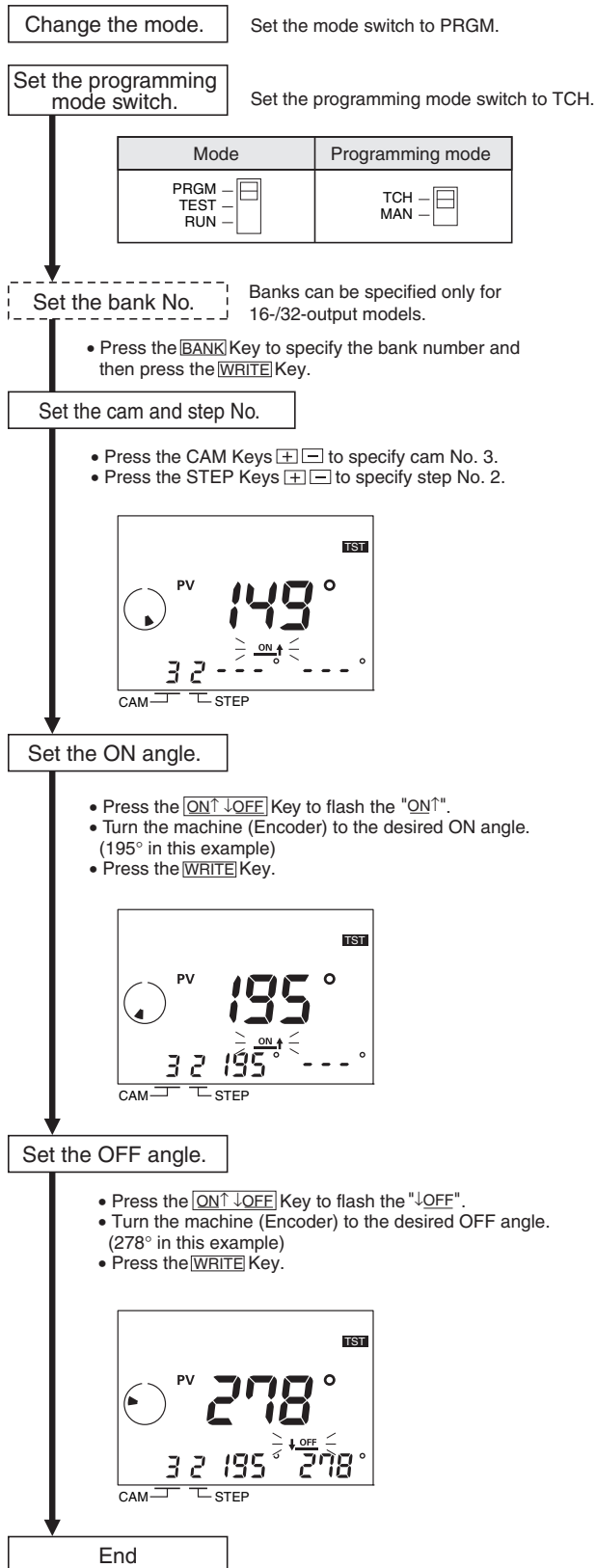

Setting ON/OFF Angles Using Support Software

With 16-/32-output models, programs can be uploaded or downloaded easily with the optional Support Software (H8PS-SOFT-V1) by connecting a personal computer to the Cam Positioner using the USB cable (Recommended USB Cables: ELECOM CO.Ltd. U2C-MF20BK).

Support Software Functions

- Writing cam programs
- Setting functions
- Editing, saving, and printing programs
- Displaying and printing cam program operation charts
- Simple simulations of programs

Applicable OS: Windows 98, 2000, ME, or XP

Refer to the user's manual for the Support Software for details.

Checking Timing (Test Mode)

Testing Operation

Operation can be tested to check operation timing.

- Set the mode switch to TEST.

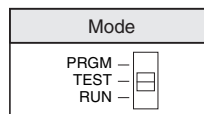

- Operate the Encoder and check the timing of operation.

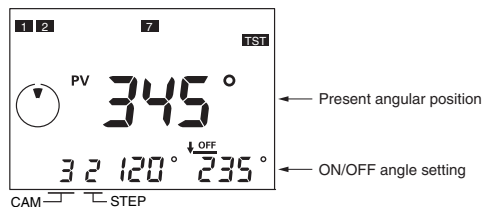

- If the timing is not correct, change the ON/OFF angle settings. The settings can be changed in Test Mode.

Note: 1. Outputs will turn ON and OFF in Test Mode. Confirm system safety before switching to Test Mode.

2. With 16-/32-output model, be sure to turn ON the start input. Outputs are not turned ON unless the start input is turned ON.

Operation (Run Mode)

Starting Operation

- Set the mode switch to RUN to start operation.

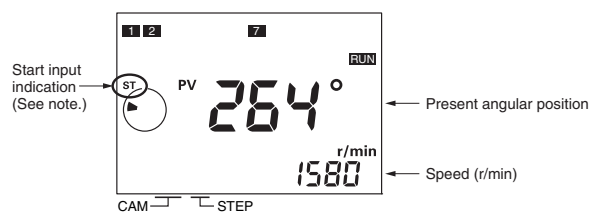
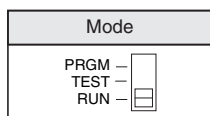

Note: For 16/32-output models, be sure that the start input is ON and that the start input indicator is lit. Outputs (including the cam, pulse, and run outputs) will not function if the start input is OFF. The 8-output models do not have a start input.

Switching the Angle and Speed Displays

- Press the **ON↑/OFF↓** Key for at least 1 s in Run Mode to reverse the display positions of the present angular position and speed (r/min) between main display and sub-display.

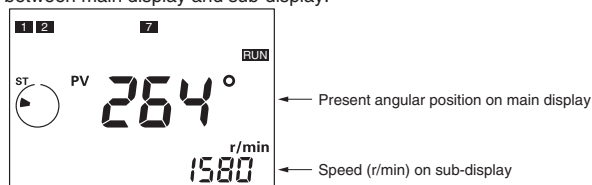

Press the **ON↑/OFF↓** Key for 1 s min.

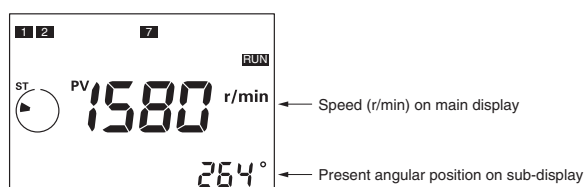

All Protection Function

The all protection function locks the H8PS in Run Mode and prohibits any changes to settings. It can be used to prevent incorrect or unauthorized operation. If the **ADV** Key is pressed for at least 5 s in Run Mode, the All Protection indicator **On RUN** will light on the display and all keys and switches will be disabled. If the mode switch is changed to Programming or Test Mode while protection is enabled, the All Protection indicator **On RUN** will flash to indicate that settings cannot be changed. If a setting on the DIP switch is changed while protection is enabled, the All Protection indicator **On RUN** will flash when the power supply is turned ON to indicate that settings cannot be changed.

All Protection Function Disabled (Normal Operation)

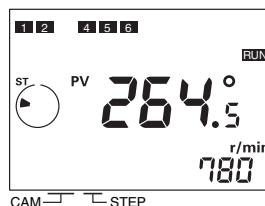

Press the **ADV** Key for 5 s min.

All Protection Function Enabled

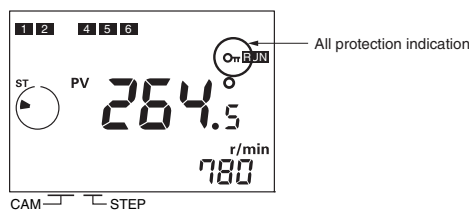

Checking ON/OFF Angle Settings

- During Run Mode, the CAM Keys **+**/**-** and STEP Keys **+**/**-** can be used to check the ON/OFF angle settings for any step. Also, the **CHECK** Key can be pressed to check the ON/OFF angle settings in order for all steps starting from cam 1. If there is no key operation for 10 s or longer during the checking operation, the previous display will be resumed.

Clearing Settings

Clearing All Programs

The all clear function can be used to delete all cam programs, the settings for advance angle compensation function, and all other settings. All settings in the Function Setting Mode will be returned to their default settings.

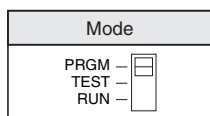

Set the mode switch to PRGM or TEST.

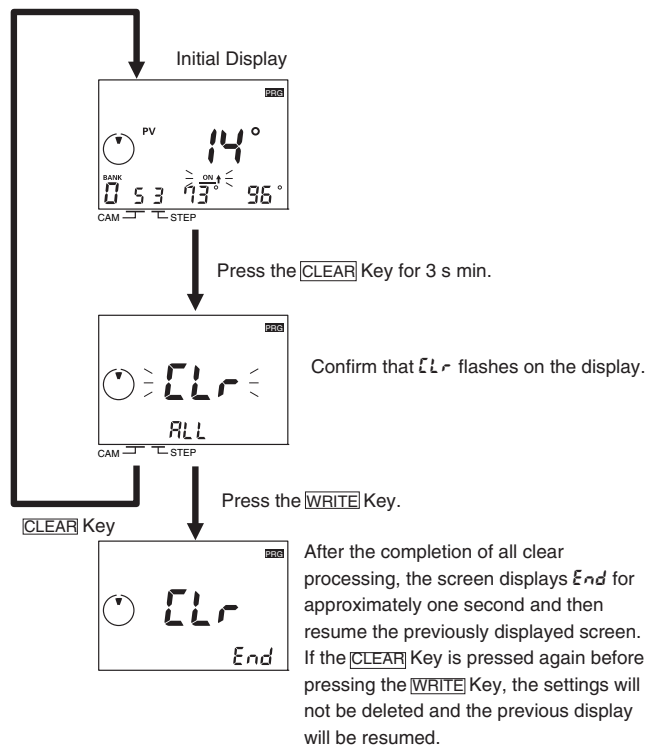

Clearing Individual Steps, Cams, and Banks

ON/OFF angle settings can be deleted by step, by cam, or by bank. If settings are deleted by cam, the settings for the advance angle compensation (ADV) function will not be deleted. If settings are deleted by bank, the settings for the ADV function will also be deleted. Settings in the Function Setting Mode will not be deleted.

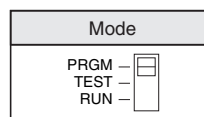

Set the mode switch to PRGM or TEST.

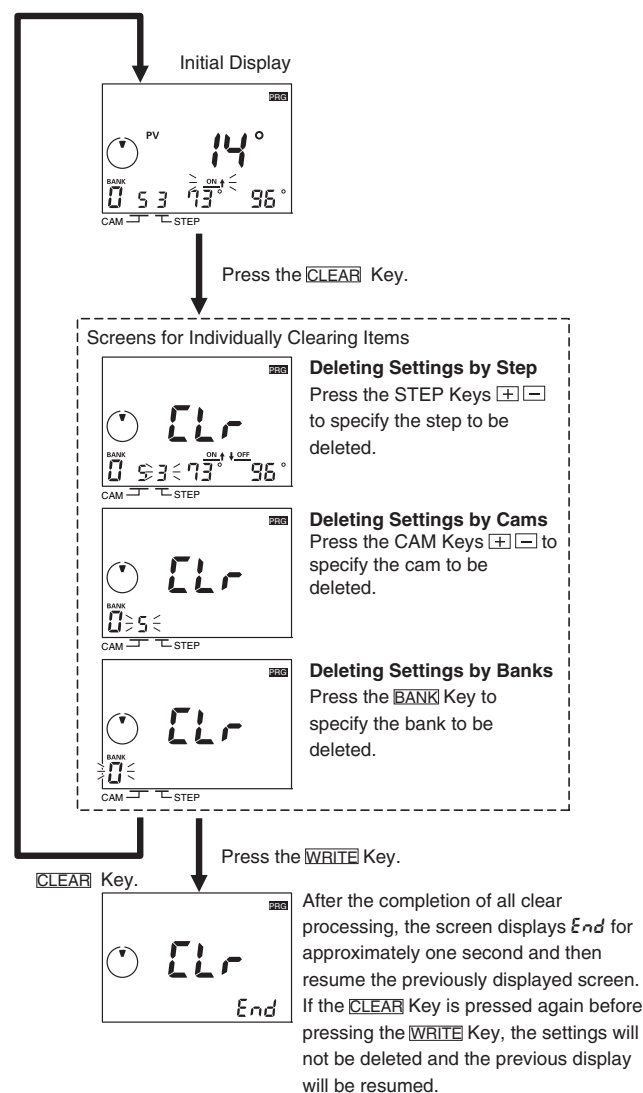

Advanced Functions

Set the advanced functions as required to perform more advanced operation. Outlines of the advanced functions are provided on the following pages. For details, refer to the *Operation Manual* (Cat. No. Z199).

Mode Transitions

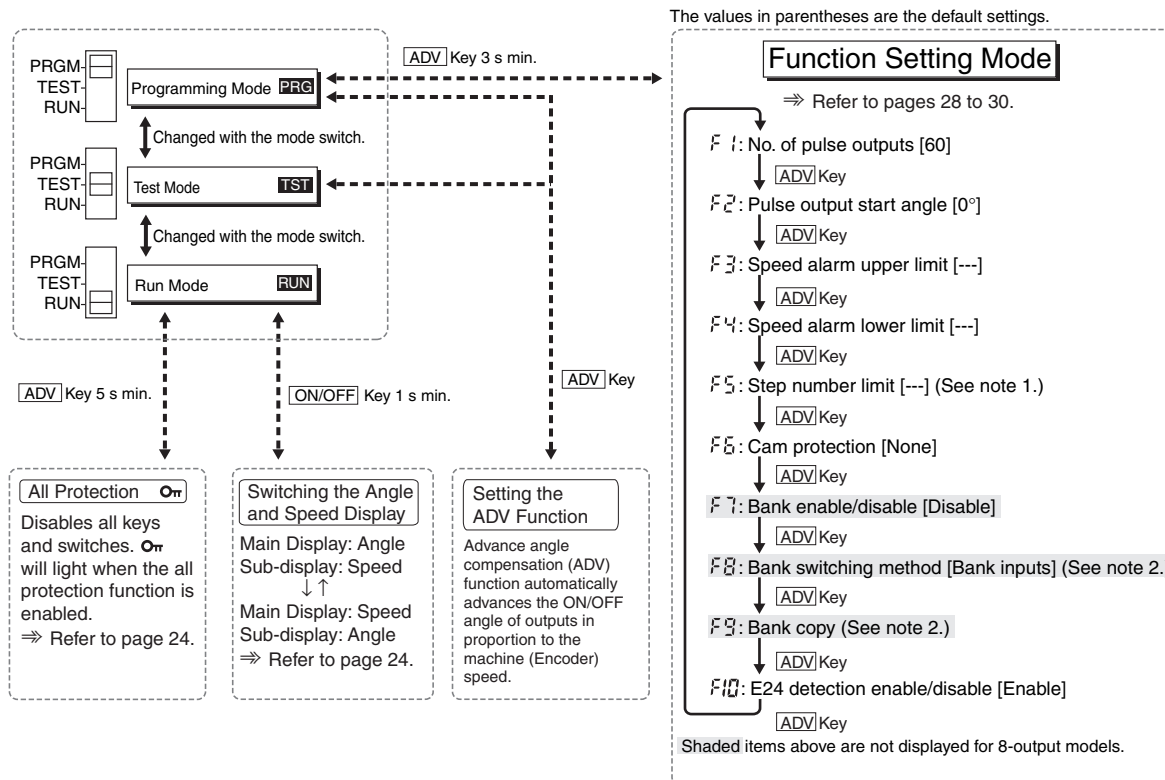

Note 1: The default setting is for 10 steps for all cams.
Note 2: Not displayed when F7 is disabled.

Advance Angle Compensation (ADV)

Function

The advance angle compensation function automatically advances the ON/OFF angle of cam outputs in proportion to machine (encoder) speed. As the speed of the machine increases, the system can be affected by the delay in outputs. If the ADV function is used, the output delay caused by higher speeds is automatically compensated.

As shown in the following diagram, ADV function is used to linearly compensate outputs according to the speed based on the ADV value setting for a specific speed.

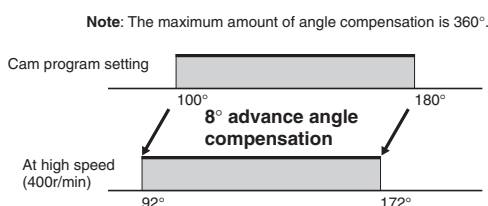
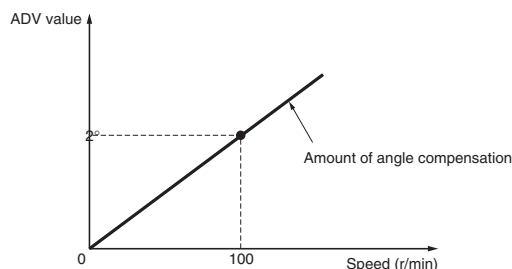

Example: ADV Value Set to 2° at 100 r/min

ADV value can be set independently for cams 1 to 7 (7 total). For the ADV function, the speed and the amount of angle compensation are set. If “- - -” is displayed for any setting, the ADV function is disabled. The setting ranges are given in the following table.

Encoder		Speed	ADV value
Resolution	Display angle		
256	256	“- - -”, 1 to 1,600	“- - -”, 0 to 255
256	360	“- - -”, 1 to 1,600	“- - -”, 0 to 359
360	---	“- - -”, 1 to 1,600	“- - -”, 0 to 359
720	---	“- - -”, 1 to 800	“- - -”, 0 to 359.5

Note: Default settings are shown in reverse type.

The maximum response speed will decrease as shown in the following table when ADV values are set for 4 cams or more.

Number of cams with ADV settings	Encoder resolution	Max. response speed
0 to 3	256/360	1,600r/min
	720	800r/min
4 to 7	256/360	1,200r/min
	720	600r/min

Note: Even if the ADV value is set to 0°, the cam must be included in the number of cams with ADV settings.

Example: Setting the ADV Value to 2° at 100 r/min for Cam 4

1. Set the mode switch to PRGM or TEST.
2. Set cam number 4 with the CAM Keys $\left[\begin{smallmatrix} + \\ - \end{smallmatrix} \right]$. (See note.)
3. Press the $\left[\text{ADV} \right]$ Key to move to the ADV function setting display and confirm that “ADV” is displayed.

Setting Display

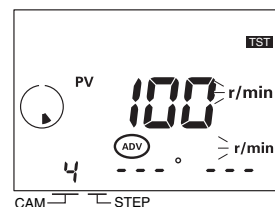

4. Set the speed to 100 with the ANGLE Keys $\left[\begin{smallmatrix} + \\ - \end{smallmatrix} \right]$ and then press the $\left[\text{WRITE} \right]$ Key.

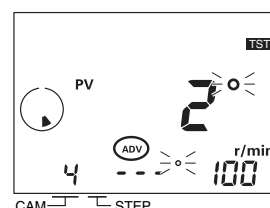

5. Set the ADV value to 2 with the ANGLE Keys $\left[\begin{smallmatrix} + \\ - \end{smallmatrix} \right]$.

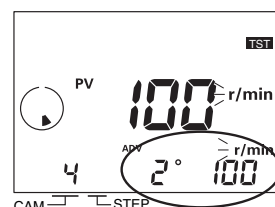

6. Press the $\left[\text{WRITE} \right]$ Key to write the settings to memory.

7. Press the $\left[\text{ADV} \right]$ Key after finishing setting the ADV function. The previous display in Programming or Test Mode will be resumed.

Note: If the bank function is being used, set the bank number before setting the cam number.

Pulse Output (F1/F2)

Outputs a preset number of pulses per Encoder rotation. Pulses are output at a 1:1 ON/OFF ratio and pulse output can be started from a specified angle.

Operation for 9 Output Pulses and a Start Angle of 0°

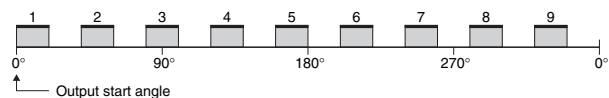

Operation for 9 Output Pulses and a Start Angle of 10°

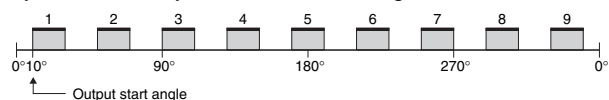

Number of Output Pulses (F1)

Select the number of pulses per rotation from the following table.

Encoder resolution	Settable number of pulses
256	1, 2, 3, 4, 5, 6, 9, 10, 12, 15, 18, 20, 30, 36, 45, 60 , 90
360	1, 2, 3, 4, 5, 6, 9, 10, 12, 15, 18, 20, 30, 36, 45, 60 , 90, 180
720	1, 2, 3, 4, 5, 6, 8, 9, 10, 12, 15, 18, 20, 24, 30, 36, 40, 45, 60 , 72, 90, 120, 180, 360

Note: Default settings are shown in reverse type.

Example: Setting 90 Pulses per Rotation

The number of pulses is set using the F1 menu in the Function Setting Mode.

Setting Display

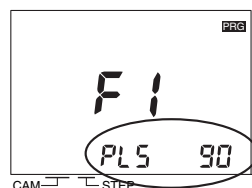

Set the number of pulses with the ANGLE Keys $\left[\right]$ and then press the **WRITE** Key.

Pulse Output Start Angle (F2)

The setting ranges are given in the following table.

Encoder		Start angle
Resolution	Display angle	
256	256	0 to 255°
256	360	0 to 359° (See note 2.)
360	---	0 to 359°
720	---	0 to 359.5°

Note: 1. Default settings are shown in reverse type.

2. The output accuracy is 2° maximum, so not all angles can be set.

Example: Setting the Pulse Output Start Angle to 100°

The starting angle for pulse outputs is set using the F2 menu in the Function Setting Mode.

Setting Display

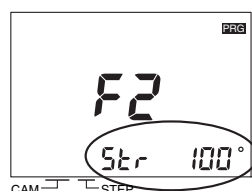

Set the pulse output start angle to 100 with the ANGLE Keys $\left[\right]$ and then press the **WRITE** Key.

Speed Alarm Outputs (F3/F4)

Specific cam outputs can be used as Encoder speed alarm outputs. Alarms can be output for upper and lower speed limits.

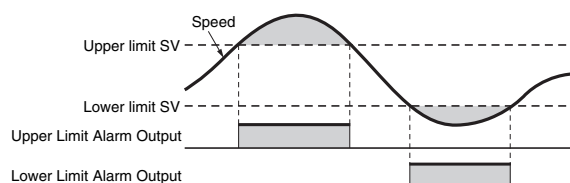

The speed alarm outputs are assigned to cam outputs as shown in the following table. The speed alarms are set to "--" for the default settings, i.e., the normal cam outputs are enabled. If a speed alarm is set to any value but "--", the normal cam output for the corresponding cam number will be disabled.

	Upper Limit Alarm Output	Lower Limit Alarm Output
H8PS-8□ (8 outputs)	Cam 7	Cam 8
H8PS-16□ (16 outputs)	Cam 15	Cam 16
H8PS-32□ (32 outputs)	Cam 31	Cam 32

The setting ranges for the upper and lower limits speed alarm are given in the following table.

Encoder resolution	Speed
256, 360	"--" or 0 to 1,600 r/min
720	"--" or 0 to 800 r/min

Note: Default settings are shown in reverse type.

Speed Alarm Upper Limit (F3)

Example: Setting the Upper Limit Set Value to 700 r/min for a 16-output Model

The upper limit set value is set using the F3 menu in the Function Setting Mode.

Upper Limit Setting Display

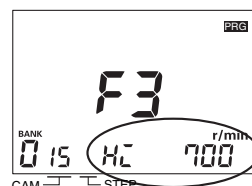

Set the upper limit set value to 700 with the ANGLE Keys $\left[\right]$ and then press the **WRITE** Key. (See note.)

Note: If banks are being used, the bank number must be set.

Speed Alarm Lower Limit (F4)

Example: Setting the Lower Limit Set Value to 20 r/min for a 16-output Model

The lower limit set value is set using the F4 menu in the Function Setting Mode.

Lower Limit Setting Display

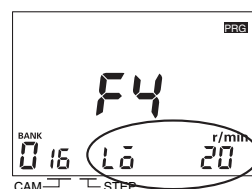

Set the upper limit set value to 20 with the ANGLE Keys $\left[\right]$ and then press the **WRITE** Key.

Note: If banks are being used, the bank number must be set.

Step Number Limit (F5)

With the H8PS, up to 10 steps can be set to turn the output ON/OFF 10 times for each cam. The number of steps that can be set, however, can be restricted to prevent programming from being added through operating mistakes. Settings can be made for all cams at once or each cam individually. The default setting for the Step Number Limit is 10 steps for all cams.

Example: Limiting the Number of Steps to 2 for All Cams Collectively.

The maximum number of steps to be set is set using the F5 menu in the Function Setting Mode.

Display for Collective Settings

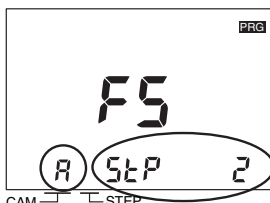

Set the cam number to **R** with the CAM Keys $\left[\begin{smallmatrix} + \\ - \end{smallmatrix} \right]$ and set the maximum number of steps to 2 with the Angle Keys $\left[\begin{smallmatrix} + \\ - \end{smallmatrix} \right]$. Press the **WRITE** Key to write the setting to memory.

The cam number can be set to **R** on the setting display to set all cams at once. If the number of steps is displayed as “- - -” when the cam number is **R**, the collective settings for all cams are disabled.

Example: Limiting the Number of Steps to 1 for Cam 3.

The maximum number of steps to be set is set using the F5 menu in the Function Setting Mode.

Display for Individual Settings

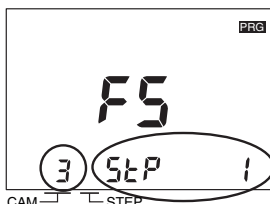

Set the cam number to 3 with the CAM Keys $\left[\begin{smallmatrix} + \\ - \end{smallmatrix} \right]$ and set the maximum number of steps to 1 with the Angle Keys $\left[\begin{smallmatrix} + \\ - \end{smallmatrix} \right]$. Press the **WRITE** Key to write the setting to memory.

Cam Protection (F6)

Cam programs can be write-protected. Use this setting to protect the programs for only specific cam numbers. Protected cam numbers will not be displayed in Programming Mode or Test Mode. Writing or changing programs will not be possible. Protected cam numbers will also not be displayed in Run Mode and cannot be checked. The default settings are for no protection for all cams.

Example: Protecting Cam 3 with an 8-output Model

Cam protection is set using the F6 menu in the Function Setting Mode.

Setting Display

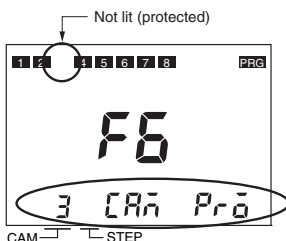

Set the cam number to be protected (and not displayed) to 3 with the CAM Keys $\left[\begin{smallmatrix} + \\ - \end{smallmatrix} \right]$ and then press the **WRITE** Key. The output display will go out.

Bank Functions (F7/F8/F9)

The bank function is supported by 16-/32-output models. Banks enable changing the entire cam program at once by switching bank numbers (0 to 7).

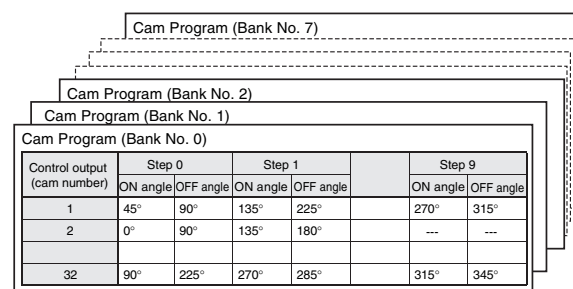

In Run Mode or Test Mode, the start input must be turned OFF and ON as shown in the following diagram in order to change banks. Control the start input when changing banks.

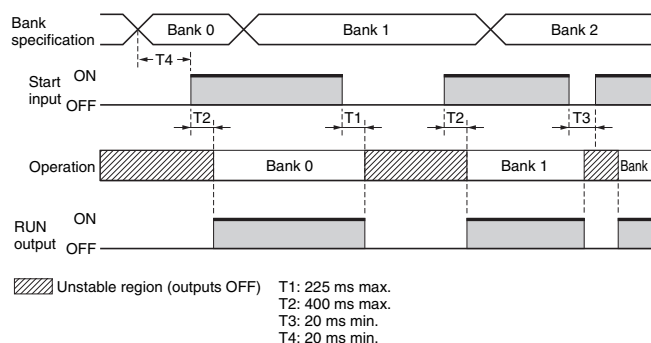

Bank Enable/Disable (F7)

The default setting disables the bank function. To use banks, change the setting using the F7 menu in the Function Setting Mode.

Setting Display

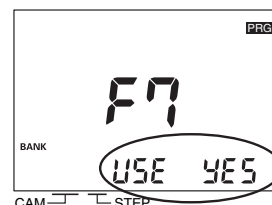

Enable or disable the bank function with the ANGLE Keys $\left[\begin{smallmatrix} + \\ - \end{smallmatrix} \right]$.



Bank Switching Method (F8)

The following methods can be used to switch the bank: the bank inputs on the terminal block or the BANK Key on the front of the Cam Positioner.

Bank Switching Method (F8)

The following methods can be used to switch the bank: the bank inputs on the terminal block or the BANK Key on the front of the Cam Positioner. The method is set using the F8 menu in the Function Setting Mode.

Setting	Display	Description
Bank input (IN)		Banks can be changed only with the bank inputs. Even if a different bank number is displayed in Programming Mode, the bank specified with the bank inputs will be used after switching to Run Mode or Test Mode.
Bank Key (KEY)	<i>KEY</i>	Banks can be changed only with the BANK Key. Bank inputs are disabled.

Note: 1. Default settings are shown in reverse type.
2. This setting can be made only when the Bank Function (F7) has been enabled.

Setting Display

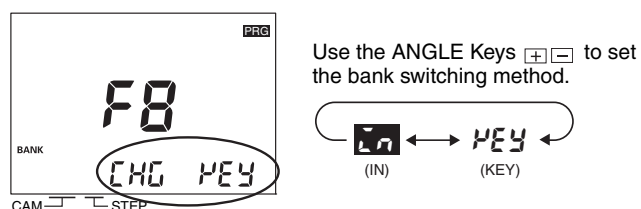

The bank inputs on the terminal block are used as shown in the following table.

Bank No.	Bank input terminals		
	1	2	4
0	OFF	OFF	OFF
1	ON	OFF	OFF
2	OFF	ON	OFF
3	ON	ON	OFF
4	OFF	OFF	ON
6	ON	OFF	ON
6	OFF	ON	ON
7	ON	ON	ON

ON: Shorted to COM terminal.
OFF: Open

Bank Copy (F9)

Programs can be copied between banks. This function is convenient to copy a program to a different bank when only some of the ON/OFF angle settings need to be changed.

Note: This operation can be used only when the Bank Function (F7) has been enabled.

Example: Copying the Program in Bank 2 to Bank 3

Banks are copied using the F9 menu in the Function Setting Mode.

Setting Display

1. Set the number of the bank to be copied.

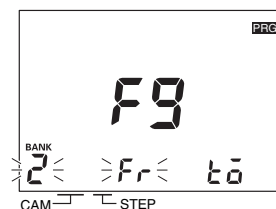

Set bank number 2 (the copy source) with the **BANK** Key and then press the **WRITE** Key.

2. Set the number of the bank to receive the copy.

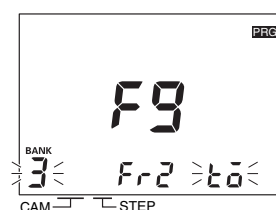

Set bank number 3 (the copy destination) with the **BANK** Key and then press the **WRITE** Key.

3. Execute the copy.

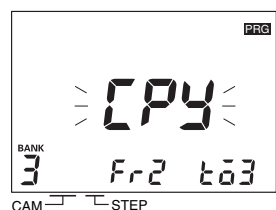

Confirm that **CPY** is displayed and then press the **WRITE** Key again.

4. Copying completed.

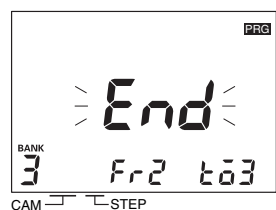

After completion of copying **End** is displayed for approx. 1 s and the previous display will be resumed.

E24 Detection (F10)

Displaying E24 errors (Encoder disconnected) can be disabled. The setting does not normally need to be changed. When the Y92C-30 Parallel Input Adapter (order separately) is used to connect more than one H8PS to the same Encoder, an E24 error can appear even if the Encoder connection is normal. If this happens, use the E24 Detection function (F10) in the Function Setting Mode to disable E24 detection displays.

Setting	Display	Description
Enabled	YES	An E24 error will be displayed if the Encoder is not connected correctly in Run Mode or Test Mode.
Disabled	<i>nō</i>	An E24 error will not be displayed even if an Encoder is not connected.

Note: Default settings are shown in reverse type.

Setting Display

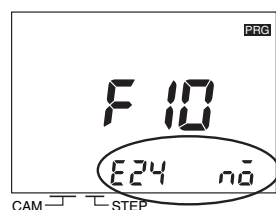

Enable or disable E24 detection with the ANGLE Keys .



Self Diagnostic Function

The following displays will appear on the main display if an error occurs. If an error occurs, all outputs (including cam, pulse, and run outputs) will be turned OFF.

Display	Meaning	Recovery method
E00	Origin designation data error	Press the CLEAR Key for at least 3 s. All settings, including the origin designation data, will be initialized.
E11	Memory error: RAM error	Cycle the power supply.
E12	Memory error: Checksum error	Press the CLEAR Key for at least 3 s. All settings, including the origin designation data, will be initialized.
E13	CPU error	Cycle the power supply.
E21	Response speed exceeded	The Encoder is rotating faster than the allowable range. Reduce the speed to within the allowable range. Then cycle the power supply or switch to Programming Mode and then to Run Mode.
E22	Encoder data error	There are surges or noise around the product or in the wiring. Check the wiring and protect the product from surges and noise. Then cycle the power supply.
E23	Encoder resolution inconsistent	Set the Encoder resolution according to the specifications of the Encoder. Then cycle the power supply.
E24	Encoder disconnected	Connect the Encoder connector properly. Then, cycle the power supply or switch to Programming Mode and then to Run Mode.

Angle Data Table

To assist with programming when using an Encoder with a resolution of 256/rotation, displays and settings may be done by conversion to 360 degrees by setting a pin on the DIP switch inside the front cover. The following table shows the conversions.

0	1	2	3	4	5	6	7	8	9	10	11	12	13	14	15
0°	1°	3°	4°	6°	7°	8°	10°	11°	13°	14°	15°	17°	18°	20°	21°
16	17	18	19	20	21	22	23	24	25	26	27	28	29	30	31
23°	24°	25°	27°	28°	30°	31°	32°	34°	35°	37°	38°	39°	41°	42°	44°
32	33	34	35	36	37	38	39	40	41	42	43	44	45	46	47
45°	46°	48°	49°	51°	52°	53°	55°	56°	58°	59°	60°	62°	63°	65°	66°
48	49	50	51	52	53	54	55	56	57	58	59	60	61	62	63
68°	69°	70°	72°	73°	75°	76°	77°	79°	80°	82°	83°	84°	86°	87°	89°
64	65	66	67	68	69	70	71	72	73	74	75	76	77	78	79
90°	91°	93°	94°	96°	97°	98°	100°	101°	103°	104°	105°	107°	108°	110°	111°
80	81	82	83	84	85	86	87	88	89	90	91	92	93	94	95
113°	114°	115°	117°	118°	120°	121°	122°	124°	125°	127°	128°	129°	131°	132°	134°
96	97	98	99	100	101	102	103	104	105	106	107	108	109	110	111
135°	136°	138°	139°	141°	142°	143°	145°	146°	148°	149°	150°	152°	153°	155°	156°
112	113	114	115	116	117	118	119	120	121	122	123	124	125	126	127
158°	159°	160°	162°	163°	165°	166°	167°	169°	170°	172°	173°	174°	176°	177°	179°
128	129	130	131	132	133	134	135	136	137	138	139	140	141	142	143
180°	181°	183°	184°	186°	187°	188°	190°	191°	193°	194°	195°	197°	198°	200°	201°
144	145	146	147	148	149	150	151	152	153	154	155	156	157	158	159
203°	204°	205°	207°	208°	210°	211°	212°	214°	215°	217°	218°	219°	221°	222°	224°
160	161	162	163	164	165	166	167	168	169	170	171	172	173	174	175
225°	226°	228°	229°	231°	232°	233°	235°	236°	238°	239°	240°	242°	243°	245°	246°
176	177	178	179	180	181	182	183	184	185	186	187	188	189	190	191
248°	249°	250°	252°	253°	255°	256°	257°	259°	260°	262°	263°	264°	266°	267°	269°
192	193	194	195	196	197	198	199	200	201	202	203	204	205	206	207
270°	271°	273°	274°	276°	277°	278°	280°	281°	283°	284°	285°	287°	288°	290°	291°
208	209	210	211	212	213	214	215	216	217	218	219	220	221	222	223
293°	294°	295°	297°	298°	300°	301°	302°	304°	305°	307°	308°	309°	311°	312°	314°
224	225	226	227	228	229	230	231	232	233	234	235	236	237	238	239
315°	316°	318°	319°	321°	322°	323°	325°	326°	328°	329°	330°	332°	333°	335°	336°
240	241	242	243	244	245	246	247	248	249	250	251	252	253	254	255
338°	339°	340°	342°	343°	345°	346°	347°	349°	350°	352°	353°	354°	356°	357°	359°

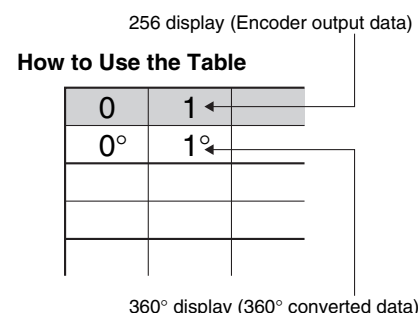

ALL DIMENSIONS SHOWN ARE IN MILLIMETERS.

To convert millimeters into inches, multiply by 0.03937. To convert grams into ounces, multiply by 0.03527.

In the interest of product improvement, specifications are subject to change without notice.

Terms and Conditions Agreement

Read and understand this catalog.

Please read and understand this catalog before purchasing the products. Please consult your OMRON representative if you have any questions or comments.

Warranties.

(a) Exclusive Warranty. Omron's exclusive warranty is that the Products will be free from defects in materials and workmanship for a period of twelve months from the date of sale by Omron (or such other period expressed in writing by Omron). Omron disclaims all other warranties, express or implied.

(b) Limitations. OMRON MAKES NO WARRANTY OR REPRESENTATION, EXPRESS OR IMPLIED, ABOUT NON-INFRINGEMENT, MERCHANTABILITY OR FITNESS FOR A PARTICULAR PURPOSE OF THE PRODUCTS. BUYER ACKNOWLEDGES THAT IT ALONE HAS DETERMINED THAT THE PRODUCTS WILL SUITABLY MEET THE REQUIREMENTS OF THEIR INTENDED USE.

Omron further disclaims all warranties and responsibility of any type for claims or expenses based on infringement by the Products or otherwise of any intellectual property right. (c) Buyer Remedy. Omron's sole obligation hereunder shall be, at Omron's election, to (i) replace (in the form originally shipped with Buyer responsible for labor charges for removal or replacement thereof) the non-complying Product, (ii) repair the non-complying Product, or (iii) repay or credit Buyer an amount equal to the purchase price of the non-complying Product; provided that in no event shall Omron be responsible for warranty, repair, indemnity or any other claims or expenses regarding the Products unless Omron's analysis confirms that the Products were properly handled, stored, installed and maintained and not subject to contamination, abuse, misuse or inappropriate modification. Return of any Products by Buyer must be approved in writing by Omron before shipment. Omron Companies shall not be liable for the suitability or unsuitability or the results from the use of Products in combination with any electrical or electronic components, circuits, system assemblies or any other materials or substances or environments. Any advice, recommendations or information given orally or in writing, are not to be construed as an amendment or addition to the above warranty.

See <http://www.omron.com/global/> or contact your Omron representative for published information.

Limitation on Liability; Etc.

OMRON COMPANIES SHALL NOT BE LIABLE FOR SPECIAL, INDIRECT, INCIDENTAL, OR CONSEQUENTIAL DAMAGES, LOSS OF PROFITS OR PRODUCTION OR COMMERCIAL LOSS IN ANY WAY CONNECTED WITH THE PRODUCTS, WHETHER SUCH CLAIM IS BASED IN CONTRACT, WARRANTY, NEGLIGENCE OR STRICT LIABILITY.

Further, in no event shall liability of Omron Companies exceed the individual price of the Product on which liability is asserted.

Suitability of Use.

Omron Companies shall not be responsible for conformity with any standards, codes or regulations which apply to the combination of the Product in the Buyer's application or use of the Product. At Buyer's request, Omron will provide applicable third party certification documents identifying ratings and limitations of use which apply to the Product. This information by itself is not sufficient for a complete determination of the suitability of the Product in combination with the end product, machine, system, or other application or use. Buyer shall be solely responsible for determining appropriateness of the particular Product with respect to Buyer's application, product or system. Buyer shall take application responsibility in all cases.

NEVER USE THE PRODUCT FOR AN APPLICATION INVOLVING SERIOUS RISK TO LIFE OR PROPERTY OR IN LARGE QUANTITIES WITHOUT ENSURING THAT THE SYSTEM AS A WHOLE HAS BEEN DESIGNED TO ADDRESS THE RISKS, AND THAT THE OMRON PRODUCT(S) IS PROPERLY RATED AND INSTALLED FOR THE INTENDED USE WITHIN THE OVERALL EQUIPMENT OR SYSTEM.

Programmable Products.

Omron Companies shall not be responsible for the user's programming of a programmable Product, or any consequence thereof.

Performance Data.

Data presented in Omron Company websites, catalogs and other materials is provided as a guide for the user in determining suitability and does not constitute a warranty. It may represent the result of Omron's test conditions, and the user must correlate it to actual application requirements. Actual performance is subject to the Omron's Warranty and Limitations of Liability.

Change in Specifications.

Product specifications and accessories may be changed at any time based on improvements and other reasons. It is our practice to change part numbers when published ratings or features are changed, or when significant construction changes are made. However, some specifications of the Product may be changed without any notice. When in doubt, special part numbers may be assigned to fix or establish key specifications for your application. Please consult with your Omron's representative at any time to confirm actual specifications of purchased Product.

Errors and Omissions.

Information presented by Omron Companies has been checked and is believed to be accurate; however, no responsibility is assumed for clerical, typographical or proofreading errors or omissions.